

Tender

Town of Gander

Invitation to Tender

Bids will be received up to the date and time indicated below for the following tender:

Tender Number: **OC24-08 Infrastructure Upgrading 2024 Contract # 2 Street Resurfacing**

Closing: Thursday July 22nd, 2024, at 2:00:00 p.m. local time

Opening: Thursday July 22nd , 2024, at 2:30:00 p.m. local time

This contract generally consists of but is not limited to the supply of all labour, plant and materials necessary to complete upgrading and paving of several streets within the Town of Gander.

Paper copies and drawings are available at the Town Hall for a cost of \$46.00 (HST Inc)

There is no charge for Electronic copies.

Tender documents may be obtained from the Town of Gander website or e-mail your request to tenders@gandercanada.com

Tenders can be couriered, or hand delivered in a sealed envelope, clearly marked on outside as to its contents and vendor name, to the Procurement Officer 100 Elizabeth Drive, Gander, NL A1V 1G7 up to closing of tender, Tenders will be opened in public at 2:30:00 p.m. Local Time.

The Town of Gander does not bind itself to accept the lowest or any bid for this tender.

Suzanne White
Procurement Officer

TOWN OF GANDER



**INFRASTRUCTURE UPGRADING 2024
CONTRACT #2
Street Resurfacing 24-302**

**Town of Gander
Engineering Department
100 Elizabeth Drive
Gander, NL A1V 1G7**

**Gas Tax Project #: 89-2024-8282
Town of Gander Tender #: OC24-08**

**Issue for Approval – June 19, 2024
Issue For Tender – July 9, 2024
Issue For Construction –**



SPECIFICATION NOTICE

"THESE PROJECT DOCUMENTS HAVE BEEN PREPARED FOR USE WITH AND REQUIRE BEING READ IN CONJUNCTION WITH THE MUNICIPAL WATER, SEWER AND ROADS MASTER CONSTRUCTION SPECIFICATIONS, LATEST REVISION, AS PUBLISHED BY THE DEPARTMENT OF TRANSPORTATION AND INFRASTRUCTURE, PROVINCE OF NEWFOUNDLAND AND LABRADOR. THIS PUBLICATION IS AVAILABLE ON THE DEPARTMENT'S WEB SITE UNDER PUBLICATIONS AT THE FOLLOWING LINK:

<https://www.gov.nl.ca/ti/files/MI-Municipal-Water-Sewer-Roads-Master-Construction-Specifications-May-2024.pdf>

***Please review all the changes published in
revised 2024 edition***

TOWN OF GANDER OH&S Advisory Notice

BIDDERS ARE ADVISED THAT PRIOR TO AWARD OF CONTRACT THEY WILL BE REQUIRED TO BE FAMILIAR WITH AND ACKNOWLEDGE COMPLIANCE WITH THE TOWN OF GANDER'S OCCUPATIONAL HEALTH AND SAFETY CONTRACTOR SAFETY PROGRAM.

COPIES OF THE TOWN OF GANDER'S CONTRACT SAFETY PROGRAM ARE AVAILABLE BY CONTACTING THE TOWN OF GANDER'S PROCUREMENT OFFICER AT (709)651-2931 OR BY EMAIL AT swhite@gandercanada.com

TABLE OF CONTENTS

	No. of Pages
Title Page	1
Specification Notice	1
Town of Gander OH & S Advisory Notice	1
Table of Contents	1
List of Drawings	1
Bid Form	5
(Including Schedule of Quantities and Prices)	
Instructions to Bidders	18
Agreement between Owner and Contractor	5
General Conditions	33
Supplementary General Conditions	6
Supplementary Specifications	3
Sample Work Schedule	1
Certificate of Insurance	1

Additional Documentation (To be added upon receipt) – Bonding, Certificate of Insurance, COR Certification, Letter of Good standing from WorkplaceNL, etc

LIST OF DRAWINGS

INFRASTRUCTURE UPGRADING 2024 CONTRACT #2 Street Resurfacing

Drawing #: 24-302

COVER SHEET

Part A	Sheet 1 of 6	Memorial Drive East Removal (Sta. 0+068.5 to Sta. 0+375.2)
Part A	Sheet 2 of 6	Memorial Drive East Construction (Sta. 0+68.5 to Sta. 0+221.6)
Part A	Sheet 3 of 6	Memorial Drive East Construction (Sta. 0+198.5 to Sta. 0+375.2)
Part A	Sheet 4 of 6	Memorial Drive East Miscellaneous Details
Part B	Sheet 5 of 6	Airport Boulevard Removal and Construction (Sta. 0+986.7 to Sta. 1+192.5)
Part C	Sheet 6 of 6	Rowsell Boulevard Removal and Construction (Sta. 0+938.2 to Sta. 1+067.8)

INSTRUCTIONS TO BIDDERS

INDEX

1. Interpretation
2. Open Call for Bids
3. Contract Documents
4. Enquiries
5. Bid Surety and Bonding
6. Bid Procedures
7. Currency and Tax Conditions
8. Ownership and Release of Information
9. Irrevocable Bid Period
10. Bidder Declarations
11. Unacceptable Bids
12. Amendments to Bids
13. Withdrawal of Bids
14. Substitution of Materials
15. Acceptance of Bid
16. Opening of Bids
17. Evaluation Process
18. Award and Signing of Contract
19. Failure to Respond to Award Notification
20. Commencement of Work
21. Town of Gander Office Closure
22. Contractor Performance
23. Safety Training and Supervision

INSTRUCTIONS TO BIDDERS

1. INTERPRETATION

- (a) This document shall be governed by and interpreted in accordance with the laws of the Province of Newfoundland and Labrador and the laws of Canada.
- (b) Where the Contractor consists of more than one person, the obligations of the Contractor shall be joint and several.
- (c) If any provision of this Contract is void, illegal, invalid or unenforceable; it shall be severable from the Contract and shall not invalidate or impair the remaining provisions of the Contract.
- (d) The Contractor is acknowledged to be an independent contractor and neither the Contractor, nor any officer, servant nor agent of the Contractor is deemed to be an employee of the Owner.
- (e) The Contract constitutes the entire agreement between the Owner and the Contractor. There are no other agreements of any kind other than those contained within the Contract.

2. OPEN CALL FOR BIDS

- (a) Envelopes containing the bid are to be clearly marked:
Bid for:
Town of Gander
Project No. OC 24-08
- (b) **Project Name:** Infrastructure Upgrading 2024 – Street Resurfacing 24-302

Addressed to:
Procurement Officer
Town of Gander
100 Elizabeth Drive
Gander, NL, A1V 1G7
(709) 651-2931

The name and address of the bidder and the closing time must be shown on the envelope.

- (b) Bids must be received on or before the exact closing time and date indicated in the advertisement. BIDS RECEIVED AFTER THAT TIME WILL NOT BE CONSIDERED OR OPENED.

INSTRUCTIONS TO BIDDERS

- (c) The Form of Agreement is included in the Contract Documents at the time of the Open Call for Bids for the purpose of information to Bidders and shall not be completed at the time of Bid submission.
- (d) Before submitting a Bid, Bidders shall carefully examine the Contract Documents and the site of the proposed work and fully inform themselves of the existing conditions and limitations. No subsequent allowance under the Contract Documents will be considered for any Bidder who had failed to become familiar with all aspects of the work.
- (e) By submitting a Bid, a Bidder represents to the Owner that the Bidder has made such examination and is satisfied as to the conditions that will be encountered in performing the Work and as to the requirements described in the Open Call for Bids.
- (f) The Owner will not defray any expenses incurred by the bidders in the preparation and submission of their bids.
- (g) Bidders shall identify any information in the bid that may qualify for an exemption from disclosure under subsection 39(1) of the **Access to Information and Protection of Privacy Act, 2015**.
- (h) This procurement is subject to trade agreements, such as the Canada Free Trade Agreement and the Canada European Union Comprehensive & Economic Trade Agreement, where applicable.

3. CONTRACT DOCUMENTS

- (a) Notices of Open Calls for Bids will be posted on the Town of Gander website www.gandercanada.com.
- (b) The Contract Documents that form part of the Open Call for Bids consist of the Instructions to Bidders, Electronic Bid Form, Agreement, General Conditions, Supplementary General Conditions, Drawings, Specifications, and any Amendments to the Contract Documents issued during the bid period.
- (c) Every interpretation of, or addition to, the Contract Documents to be considered a valid part of the Contract Documents will be issued in the form of a written amendments.
- (d) No amendments will be issued less than five (5) days prior to the closing date of the Open Call for Bids.
- (e) Bidders are responsible for ensuring they have received all Open Call for Bids Amendments and are advised to check the Town of Gander website for Open Call for Bids Amendments before

INSTRUCTIONS TO BIDDERS

submitting their Bids.

- (f) Bidders acknowledge all amendments by submission of bid documents

4. ENQUIRIES

- (a) A Bidder is solely responsible for obtaining all information that may be necessary in order to understand the requirements of the Open Call for Bids and to submit a Bid in accordance with the terms and conditions of the Open Call for Bids.
- (b) If a Bidder finds errors, discrepancies or omissions in the Open Call for Bids, the Bidder should notify the Contract Administrator of the error, discrepancy or omission as soon as possible. If a Bidder is unsure of the meaning or intent of any provision in the Open Call for Bids, the Bidder should request clarification from the Contract Administrator.
- (c) All enquiries related to the Open Call for Bids must be directed, in writing, to the Contract Administrator identified in the Open Call for Bids.
- (d) Responses to enquiries which, in the sole judgment of the Contract Administrator, require a correction or modification to the Open Call for Bids will be provided by an Amendment.
- (e) Responses to enquiries which, in the sole judgment of the Contract Administrator, do not require a correction or modification to the Open Call for Bids, will be provided by the Contract Administrator only to the Bidder that made the enquiry.
- (f) A Bidder is not entitled to rely on any response or interpretation received pursuant to an enquiry unless that response or interpretation is provided in writing by the Contract Administrator or by an Amendment to the Open Call for Bids.
- (g) If a Bidder has sent an enquiry and has not received any acknowledgement of its enquiry, the Bidder should follow up with the Contract Administrator.
- (h) Enquiries received within 48 hours of the Submission Deadline may not receive a response from the Contract Administrator.

5. BID SURETY AND BONDING

- (a) Bidding Security
 - (i) Every Bidder shall submit with the Bid a bid bond issued by

INSTRUCTIONS TO BIDDERS

an approved Surety Company licensed to do business in the Province of Newfoundland and made out in favor of the Owner.

- (ii) The bid bond shall be at least ten percent (10%) of the bid amount. All bids, regardless of monetary value require a Bid Security of at least ten percent (10%) of the total bid amount, with a minimum security of five hundred dollars (\$500.00)." Bid Securities shall be in the form of a Bid Bond or Certified Cheque in favour of the Owner. An approved certified cheque may be substituted in lieu of the bid bond. The bidding security will be returned upon receipt of the Performance and Labour and Materials Bonds.
- (iii) For bids less than \$25,000.00, the terms of the Bid Security will be invoked and the amount retained by the Owner, if the Bidder fails to provide the required insurances and commence work within 30 days of being notified of the award of the work within the Open Call for Bids validity period.
- (iv) The Bid Security of the unsuccessful bidders numbers 2 & 3 will be returned to them upon receipt of documentation from successful bidder or expiry of irrevocable bid period whichever comes first. Bid Securities of bidders higher than 3 will be returned after the Open Call for Bids opening.
- (v) Failure to submit a bid security in accordance with this requirement will result in rejection of bid submitted.
- (vi) The terms of the bid security will be invoked and the amount retained by the Owner if the Bidder fails to enter into an agreement when notified of the award of the work within the

Open Call for Bids validity period; or fails to provide the Performance and Labour and Materials Bonds in the amount and within the period specified.

(b) Performance Bond

- (i) A Performance Bond will be required in the amount of fifty percent (50%) of the contract price. The Performance Security is to be received not later than two (2) weeks after the award of the contract and prior to the formal execution of the agreement. No work is to be undertaken until the Performance Security has been received. Performance Security will not be required for a contract value of less than \$25,000.

INSTRUCTIONS TO BIDDERS

- (ii) In lieu of the Performance Bond, the Owner may accept at their sole discretion an approved certified cheque for ten percent (10%) of the bid amount. The cheque will be retained until satisfactory completion of the work including the warranty period, after which this amount will be returned to the Contractor together with the accrued interest thereon at the current bank rate.

- (c) Labour and Materials Payment Bond
 - (i) A Labour and Materials Payment Bond will be required in the amount of fifty percent (50%) of the contract price, not including the Harmonized Sales Tax (HST). The Labour and Materials Payment Bond is to be received not later than two (2) weeks after the award of the contract and prior to the execution of the formal agreement. No work is to be undertaken until the Labour and Materials security has been received. Labour and Materials security will not be required for a contract valued at less than \$25,000.
 - (ii) In lieu of the Labour and Materials Bond, the Owner may accept at their sole discretion an approved certified cheque of ten percent (10%) of the bid amount. The cheque will be retained until substantial completion of the work. This security, if in the form of a cheque, will be returned to the Contractor together with the accrued interest thereon at the current bank rate.

- (d) Bonds
 - (i) Contractors may provide Bid Bonds, Performance Bonds as well as Labour and Material Payment Bonds in either paper or electronic format (e-Bonds).
 - (ii) In accordance with the recommendations of the Surety Association of Canada, the e-Bonds shall be digitally verifiable through a third party digital certification service provider that can maintain integrity of e-Bond content and provide secure access to the e-Bond such as Mobile Bonds, Xenex Enterprises or Trisura Guarantee Insurance Company.
 - (iii) All security bonds, paper or e-Bonds are to be submitted with bid submissions.

- (e) Contractors are advised that Certified Cheques, Money Orders, or Bank Drafts from a recognized financial institution registered to do

INSTRUCTIONS TO BIDDERS

business in the Province of Newfoundland and Labrador, are acceptable forms of Bid Surety and Bonding in lieu of Bonds for Bid Security, Performance Bonds, and Labour & Materials Payment Bonds. No other forms of Bid Surety and Bonding, including cash, will be accepted.

- (f) Where a certified cheque, money order or bank draft is the format chosen by the bidder, the bidder may submit the certified cheque, money order or bank draft prior to closing, or via registered post. The registered post must be received no later than two (2) business days after the submission deadline or the bid will be disqualified. The bidder must scan a copy of the certified cheque and registered mail receipt and include the documentation with the electronic bid.

6. BID PROCEDURES

- (a) The Bid Form is to be completed in its entirety and submitted in the envelopes provided and the name of the bidder entered in the "Name of Bidder" space on the bid envelope. The bidder should retain a copy of the bid for their records.

- (b) Type or legibly print in ink the information required on the Bid Form.

- (c) Type or legibly print in ink the bidder's full business name and address in the spaces provide on the Bid Form.

- (d) Sign the Bid Form in the space provided as indicated:

-In the case of a Sole Proprietorship, the Sole Proprietor will sign where indicated in the presence of a witness who will sign where indicated. Insert the words "Sole Proprietor" next to the signature.

-In the case of a Partnership, all partners will sign where indicated in the presence of a witness who will also where indicated, Insert the word "Partner" next to signatures.

-In the case of a Limited Company, authorized signing officers in the presence of a witness who will also sign where indicated, and the corporate seal will be affixed as indicated. Indicate next to signature the corporate title of each signer.

- (e) Spaces or Appendices will be provided with the Bid Form if required for a list of subcontractors, use of bid depository, contractor's experience, and list of equipment. All such spaces and appendices must be completed in their entirety legibly by typewriter or by printing in ink.

INSTRUCTIONS TO BIDDERS

- (f) If it becomes necessary to correct an error made on the Bid Form, such correction must be initialed and dated by the person or persons signing the Bid Form.
- (g) Bids must be submitted before the Submission Deadline, using one of the submission methods specified in the Open Call for Bids for this purpose.
- (h) Bids received by the Town of Gander after the Submission Deadline or by an unacceptable submission method, will be rejected.
- (i) The Owner may extend the Submission Deadline by issuing an Amendment to the Open Call for Bids at any time before the Submission Deadline.
- (j) For the purpose of the evaluation of Bids received:
 - (i) the bid shall be the Total Bid Amount.
 - (ii) Work associated with Separate Prices may be deleted at the sole discretion of the Owner at the time of contract award and a deduction(s) will be made to the Total Bid Amount equal to the amount(s) indicated in the Bid Form.
 - (iii) Costs associated with Unit Price work will vary depending upon the quantities authorized by the Owner during the course of construction and the final contract amount will be adjusted accordingly, upwards or downwards, based upon the quoted unit rate, within the limits of the **Public Procurement Act**.
- (k) If the Owner requests more information about a Bidder's legal name or status, address or contact information, the Bidder must provide the Owner with such information within three (3) calendar days of the request. Failure to provide The Owner with the requested information within such time period may result in that Bidder's Bid being rejected.
- (l) It is solely the Bidder's responsibility to ensure that its Bid and any Bid change or Bid withdrawal is received prior to the Submission Deadline.

INSTRUCTIONS TO BIDDERS

7. CURRENCY AND TAX CONDITIONS

- (a) All prices must be quoted in Canadian dollars.
- (b) The Owner certifies that the amounts payable to the successful Bidder for the Work will be paid by the Owner's funds.

8. OWNERSHIP AND RELEASE OF INFORMATION

- (a) Bids that are not withdrawn in accordance with these Bidding Procedures become the property of the Owner after the Submission Deadline.
- (b) The Bidder is advised that any information contained in a Bid may be released by the Owner in original or other forms if authorized or required by the Owner's or the Government of Newfoundland and Labrador's policies or procedures, including these Bidding Procedures, or by any law, including The ***Auditor General Act (Newfoundland and Labrador)***, and the ***Access to Information and Protection of Personal Privacy Act (2015)***.
- (c) The financial value of the contract will be publicly released by the Owner as a part of the award notification.

9. IRREVOCABLE BID PERIOD

- (a) The Owner will endeavor to award a Contract within the specified validity period; however, Bids are irrevocable for sixty (60) calendar days after the Submission Deadline. A Bidder is bound to enter into the Contract if it is awarded the Contract during this period of irrevocability.
- (b) The Owner may request that Bidders agree to an extension of this period of irrevocability. The Bid of each Bidder that consents to such an extension remains irrevocable for the additional time requested by the Owner. The Bid of each Bidder that does not consent to such an extension remains irrevocable for the irrevocable bid period currently in force upon the Bid.
- (c) No Bidder has any obligation to enter into a Contract with the Owner upon the expiration of the irrevocable bid period. Where the irrevocable bid period in force upon a Bid has expired, further Bid information will not be released by the Owner provided the Bidder has so requested.

INSTRUCTIONS TO BIDDERS

10. BIDDER DECLARATIONS

- (a) In submitting a Bid, the Bidder declares that the Bidder:
 - (i) is incorporated and in good standing under ***The Corporations Act (Newfoundland and Labrador)***, or otherwise authorized or permitted to legally carry on business in the Province of Newfoundland and Labrador;
 - (ii) is financially capable of carrying out the terms of the Contract; and
 - (iii) possesses all the necessary experience, capital, organization, and equipment to perform the Work in accordance with the terms and conditions of the Contract.

- (b) In submitting a Bid, the Bidder declares and represents that it has not knowingly participated in bid-rigging, collusion, or fraud in the preparation of its Bid. Further, the Bidder declares and represents that it has produced the Bid independently from, and without consultation, communication, agreement or arrangement with, any competitor, except where the competitor intends to become a Subcontractor for a portion of the Work or intends to form a joint venture arrangement with the Bidder.

- (c) The Bidder is advised that, under ***the Competition Act (Canada)***, the Bidder is responsible for notifying the Owner of any aforementioned agreements or arrangements with its competitors.

- (d) In submitting a Bid, the Bidder declares and represents that the Bidder does not knowingly have a conflict of interest related to the performance of the Work by the Bidder or by its Subcontractors. If the Bidder is in doubt as to whether individuals or circumstances give rise to a conflict of interest, the Bidder should consult with the Contract Administrator prior to submitting a Bid. The Owner may reject any Bid if, in its sole discretion, the Owner determines that an actual or potential conflict of interest exists.

- (e) By submitting a Bid, the Bidder agrees that:
 - (i) the Open Call for Bids, in its entirety, is deemed to be incorporated into and form part of the Bid notwithstanding that all parts of the Open Call for Bids may not be attached to or accompany the Bid;
 - (ii) all Open Call for Bids amendments have been received, considered and addressed in the Bid;

INSTRUCTIONS TO BIDDERS

- (iii) any changes to the submitted Bid received by the Town of Gander before the Submission Deadline form part of the Bid;
 - (iv) any proposals, counter-offers, qualifications or changes to the terms, conditions or specifications in the Open Call for Bids by the Bidder will not be accepted by the Owner but will be disregarded and will not be incorporated into the Contract;
 - (v) if they are the preferred Bidder, the Bidder will enter into a Contract with the Owner to complete the Work in accordance with the Bid and the terms, conditions and specifications contained in the Open Call for Bids; and
 - (vi) the Bid will form part of the Contract.
- (f) Bidders will not engage in any form of political or other lobbying whatsoever in relation to the Open Call for Bids, including for the purpose of influencing the outcome of the process. Further, no such person (other than as expressly contemplated by this Open Call for Bids) will attempt to communicate in relation to the Open Call for Bids, directly or indirectly, with any representative of the Owner or the Government of Newfoundland and Labrador (GNL) (including any Minister or Deputy Minister, or any Members of the House Assembly, or any employee of the GNL), or any director, officer, employee, agent, advisor, consultant or representative of any of the foregoing, as applicable, for any purpose whatsoever. In the event of any lobbying or communication in contravention of this Section, the Owner in its sole and absolute discretion may at any time, but will not be required to, reject any and all bids submitted by that proponent without further consideration or compensation.

11. UNACCEPTABLE BIDS

- (a) Bids received after the Open Call for Bids Closing time will not be considered.
- (b) Incomplete Bids will be rejected.
- (c) Bids not accompanied by an approved security in the correct amount will be rejected.
- (d) Bids containing qualification or additional clauses to the Bid Form will be rejected.
- (e) Incorrectly prepared Bids may be rejected.

INSTRUCTIONS TO BIDDERS

12. CHANGES TO BIDS

- (a) Any changes to a Bid must be completed by changing the Bid before the Submission Deadline. However, the bidder is solely responsible for ensuring that the changed bid is received by the bidding system by the Submission Deadline.
- (b) Where a change affects one or more Prices, the Bidder is reminded to make changes to all affected Prices (including HST).
- (c) If, in the Owner's opinion, there is any ambiguity about the nature or effect of any change, the Owner may reject such a change and evaluate the Bidder's Bid without regard to the change.

13. WITHDRAWAL OF BIDS

- (a) A Bidder may withdraw a Bid without penalty at any time before the Submission Deadline by giving written notice to the Town of Gander for this purpose. A Bid withdrawal must be received at the Submission Location before the Submission Deadline.
- (b) Where a Paper Bid has been submitted, a Notice of Bid Withdrawal, signed by a representative of the Bidder with the authority to bind the Bidder, must clearly state the name of the Bidder and the number of the Open Call for Bids to which the Bid was responding, and should state the address of the Bidder.
- (c) If the Owner receives notice of a Bid Withdrawal before the Submission Deadline, the Owner will not consider the Bid during the Bid Evaluation and will return the Bid to the Bidder only at the request and expense of the Bidder.

14. SUBSTITUTION OF MATERIALS

- (a) Bids shall be based upon using the materials or products as specified without substitution. Where two or more brand names are specified the choice shall be left to the Contractor. Where only one brand name is stated there shall be no substitution.
- (b) Where the Specifications include the "or approved equal" clause, substitutions may be proposed provided that:
 - (i) the request for a substitution is made in writing at least seven (7) prior to the Submission Deadline.
 - (ii) the request shall clearly define and describe the product for

INSTRUCTIONS TO BIDDERS

which the substitution is requested.

- (iii) the substituted article is equivalent to the specified article with regards to design, function, appearance, durability, operation and quality.
- (c) Approval of the substitution by the Owner's Representative shall be in the form of an amendment to the Specifications issued at least five (5) days prior to the Submission Deadline to all of those Bidders listed as having received a copy of the Open Call for Bids Documents.

15. ACCEPTANCE OF BID

- (a) The Owner will not necessarily accept the lowest or any Bid.
- (b) Upon written acceptance of the Bid within the Open Call for Bids validity period, the Bid Form becomes part of the Contract Documents and the successful bidder becomes the Contractor.
- (c) The Contractor will be required to execute a formal agreement with the Owner within two (2) weeks of the date of the letter of intent to award or letter to award.

16. OPENING OF BIDS

- (a) Bids received by the Submission Deadline will be opened publicly by the Town of Gander at the Submission Location immediately after the Submission Deadline.
- (b) The Owner will publicly post the bid results after the Submission Deadline.
- (c) Where an Open Call for Bids requires the submission of a bid bond (whether electronic or paper) but the bid bond has not been received prior to the Submission Deadline, the corresponding Bid will be rejected.
- (d) All Bids which were received at the time of the public opening will be evaluated after the public opening.

17. EVALUATION PROCESS

- (a) Bids that were opened at the public opening in the Report After Open Call for Bids Call (**Unofficial Results**) will be reviewed and evaluated by the Owner after the public opening.

INSTRUCTIONS TO BIDDERS

- (b) The process of evaluating Bids is as follows:
 - (i) Determine Bid Compliance (Pass/Fail),
 - (ii) Compare Total Prices,
- (c) Determining Bid Compliance (Pass/Fail)
 - (i) The Owner will evaluate all Bids that were opened at the time of public opening to determine whether they comply with the requirements of the Open Call for Bids.
 - (ii) Bids which the Owner determines, in its sole discretion, comply with the requirements of the Open Call for Bids will progress to the second step of the evaluation process. The Owner may reject a Bid submission if it is incomplete, incorrect or conditional, or contains additions, deletions,
 - (iii) alterations or other irregularities. Bids which the Owner determines do not comply with the requirements of the Open Call for Bids will not progress to the second step of the evaluation and will be rejected.
 - (iv) The Owner may waive irregularities or reject all or any Bids if, in the sole discretion of the Owner, it is deemed appropriate.
- (d) Comparing Total Prices:
 - (i) The Owner will compare the Total Prices of all compliant Bids to determine the Bid ranking. All compliant Bids will be assigned their respective places in order of lowest Total Price to highest Total Price. The preferred Bidder is the Bidder that submitted the compliant Bid with the lowest Total Price.
 - (ii) Where a Bidder fails to provide a Lump Sum Price, Separate Price, or Unit Price as identified in the Electronic Bid Form, the Bid will be rejected.
- (e) The Owner has the right to contact not only any of the references provided by the Bidder, but also any other references identified by the Owner who have had dealings with the Bidder or the Bidder's Subcontractors without prior notice to the Bidder.
- (f) If a preferred Bidder is rejected, the Bidder with the second-lowest Total Price becomes the preferred Bidder, and so on until either a

INSTRUCTIONS TO BIDDERS

Contract is awarded to a qualified Bidder having submitted a compliant Bid or the Open Call for Bids is cancelled.

- (g) A Bidder will be notified, in writing, if its Bid is rejected.

18. AWARD AND SIGNING OF CONTRACT

- (a) The Owner is under no obligation to award a Contract to a Bidder, even if one or more Bids are determined to be compliant and one or more Bidders are determined to be qualified. Without limiting the generality of the foregoing, the Owner will have no obligation to award a Contract where:
 - (i) there is only one Bid received;
 - (ii) the prices exceed the funds available for the Work;
 - (iii) the prices materially exceed prices for similar work in the past;
 - (iv) the prices materially exceed the Owner's cost to perform the Work, or a significant portion thereof, with its own forces;
 - (v) the prices are unbalanced;
 - (vi) in the sole opinion of the Owner, the interests of the Owner would be best served by not awarding a Contract.
- (b) If no Contract is awarded, the Owner will give written notice to all Bidders, that no Contract award will be made and (where applicable) will post a notice on the Town of Gander website that the Open Call for Bids has been cancelled and no further Bid information will be released, provided the Bidder has so requested.
- (c) If the Owner decides to award a Contract, it will award the Contract to the qualified Bidder that has submitted a compliant Bid with the lowest Total Price.
- (d) The successful Bidder will be notified in writing that the Bidder has been awarded the Contract, subject to the Bidder complying with the specific conditions precedent to the Contract as set out in the Open Call for Bids or the notification of award.
- (e) The Bidder shall, within two (2) weeks after the date on which the notification of award was sent to the Bidder, demonstrate to the Owner that the Bidder has satisfied any conditions precedent to the Contract or in the notification of award. The Owner will execute the Contract and send a copy to the Contractor upon being satisfied

INSTRUCTIONS TO BIDDERS

that the requirement of this section is being met.

19. FAILURE TO RESPOND TO AWARD NOTIFICATION

- (a) If, within two (2) weeks after the date on which the award notification was sent to the Bidder, the Owner has not received all of the following from the Bidder:
 - (i) the Contract, duly signed by the Bidder (if applicable);
 - (ii) a performance bond (if applicable);
 - (iii) a labour and material payment bond (if applicable); and
 - (iv) evidence that the Bidder has satisfied any conditions precedent to the Contract;

- (b) then the Owner may do one or more of the following:
 - (i) where a bid bond was required, claim against the bid bond;
 - (ii) declare the Bidder ineligible to bid on Open Call for Bids issued by the Owner for a period of up to two (2) years;
 - (iii) proceed to award the Contract to, another Bidder;
 - (iv) cancel the Open Call for Bids;
 - (v) exercise whatever other remedies are available by law.

20. COMMENCEMENT OF WORK

- (a) Unless otherwise authorized by the Owner, in writing, the Contractor shall not commence any Work until the Contractor has:
 - (i) submitted an approved performance bond (if required);
 - (ii) submitted an approved labour and material payment bond (if required);
 - (iii) submitted confirmation of all required insurances.
 - (iv) submitted a Site Specific Safety Plan acceptable to the Owner which shall also include accommodations for any current public health guidelines and advisories;
 - (v) complied with the conditions precedent to the Contract;

INSTRUCTIONS TO BIDDERS

- (vi) confirmed that the Owner has executed the Contract that was signed and submitted by the Contractor and,
- (vii) attended a pre-construction meeting (if required).
- (viii) Submitted Town of Gander Health & Safety Questionnaire.
- (ix) Contractors Orientation Acknowledgement letter.
- (x) Pre-work Hazard Assessment.

21. TOWN OF GANDER OFFICE CLOSURE

- (a) In the event the Town of Gander office is closed, any OpenCall for Bids that would have closed on that day will be deferred to close at the same time on the next work day that normal hours are resumed.
- (b) Other than as impacted above, bids, changes to Bids, etc., will be accepted at the Town of Gander on or before the deferred closing time and date. Bids received after this deferred time and date will not be considered.

22. CONTRACTOR PERFORMANCE

- (a) Performance monitoring is required in accordance with the Public Procurement Act and Regulations. Upon completion of each contract, the contractor's performance will be evaluated according to prescribed criteria.
- (b) In accordance with Public Procurement Regulations Section 26, bidding privileges may be suspended due to noncompliant performance on a single contract or substandard performance on two (2) or more contracts.

23. SAFETY TRAINING AND SUPERVISION

- (a) Contractors shall ensure that work covered under these documents conforms, where required, to the following procedures and regulations set out by the Occupational Health and Safety Branch of Digital Government and Service NL or the Explosives Division of Energy, Mines and Resources Canada:
 - (i) Transportation of Dangerous Goods
 - (ii) Navigation of Overhead Wires

INSTRUCTIONS TO BIDDERS

- (iii) Use of Explosives
 - (iv) Working in Confined Spaces
 - (v) Highway Flagging and Signage
 - (vi) Workplace Hazardous Materials Information System
 - (vii) Working with Small Tools/Shop Equipment
 - (viii) First Aid and CPR
 - (ix) Safety Committee
 - (x) CSA Z275.2-92 Occupational Safety Code for Diving Operations
 - (xi) Other applicable health or safety procedures or regulations.
- (b) Contractors shall complete the "Safety Training and Supervision Certificate" before construction commences and supply proof of pertinent health and safety training of workers and supervisors.
- (c) On projects where blasting is to be done, the contractor shall file an Emergency Response Assistance Plan with the Explosives Division of Energy, Mines and Resources Canada.

TOWN OF GANDER



**Open Call for Bids
Bid Form**

Bid for: **Owner:** Town of Gander
Project Name: Infrastructure Upgrading 2024 Contract #2, Street Resurfacing
Project Number: Gas Tax Project #: 89-2024-8282, Town of Gander
Tender #: OC24-08

To: Suzanne White – Procurement Officer
 Department of Administration and Finance
 100 Elizabeth Drive
 Gander, NL, A1V 1G7

1. Having carefully examined the site of the proposed work and all conditions affecting such, as well as the Contract Documents including the Specifications, all Drawings listed in the Specifications, all Amendments, and the Instructions to Bidders for this project; and hereby acknowledge the requirements of the Instructions to Bidders,

 WE, THE UNDERSIGNED, offer to furnish all necessary Labour, materials, superintendence, plant, tools and equipment, and everything else required to perform expeditiously and complete in a satisfactory manner the work for the sum as indicated on Appendix A of this Bid Form.
2. The Work will be substantially performed within 30 working days from the date of notification of award of contract.
3. WE hereby acknowledge receipt of amendments issued related to this procurement.
4. In order for a Bid to be valid, it must be signed by duly authorized officials as indicated in the Instructions to Bidders.

SIGNATURE OF BIDDER

Firm Name: _____

Address: _____

Postal Code: _____ E-Mail _____

Ph # _____

Corporate Seal

Signing Officer

Signing Officer

Witnessed by

**APPENDIX "A"
BID PRICE TABLE**

Schedule of Quantities and Prices

Division	Description	Sub Total
	Part A – Memorial Drive East	
	Part B – Airport Boulevard	
	Part C – Rowsell Boulevard	
	SUB TOTAL BID AMOUNT	\$
	HARMONIZED SALES TAX (HST)	\$
	TOTAL BID AMOUNT	\$

Note: The quantities indicated for the unit prices above shall not be exceeded without an approved change order.

Appendix "A"

TOWN OF GANDER - Street Upgrade 2024 - Memorial Drive East - Part A

The quantities set out in this schedule are estimated quantities only and are not to be taken as final quantities by the Contractor. The unit prices bid shall include all labour, plant, materials, overhead, duties, and profit and all other obligations and liabilities under the contract. Do not include taxes in unit or lump sum prices, taxes due to be added on the last page of this schedule as indicated on the bottom. Totals shall be determined by multiplying the quantity by the tendered unit price.

SECTION	DESCRIPTION	UNIT	QUANTITY	UNIT PRICE	TOTAL
1010	Mobilization & Demobilization (not greater than 5% if on the Island or 10% if in Labrador, or 15% north of Cartwright of item as. "Sub-total" on last page)	L.S.	unit	_____	_____
1570	Traffic Regulations				
	Flagpersons Wages	Hour	180	_____	_____
	Traffic Control	L.S.	Unit	_____	_____
1580	Projects Signs & Sign Posts & Installation				
	Project Signs (Drawing 04010 or Infrastructure Project Sign))	L.S.	Unit	_____	_____
2070	Sitework, Demolition & Removal of Structures				
	Removal of Asphalt Pavement (up to 110mm thick)	m ²	2432	_____	_____
	Removal of Storm Sewers	m	24	_____	_____
	Removal of Sign Post	Each	2	_____	_____
2224	Roadway Excavation, Embankment & Compaction				
	1. Mass Excavation and Backfill				
	1. Common	m3	2014	_____	_____
	2. Imported Backfill				
	1. Rock (100mm minus)	m3	1239	_____	_____
2233	Selected Granular Base & Sub Base Materials				
	1. Class "A"				
	a. Granular Base	m3	310	_____	_____
	b. Shouldering	m3	42	_____	_____
	2. Class "B" Granular Sub-base	m3	464	_____	_____

2250 Calcium Chloride

Calcium Chloride	tonne	1	_____	_____
------------------	-------	---	-------	-------

2270 Rip-Rap Protection

Rip-Rap Hand Laid With Sod	m ³	2	_____	_____
----------------------------	----------------	---	-------	-------

2434 Pipe Culverts

Supply & Placement of Pipe Culvert 1. 375mm dia HDPE	m	18	_____	_____
---	---	----	-------	-------

2481 Channel Excavation, Cleaning & Deepening

Cleaning & Deepening of Existing Channels	m	450	_____	_____
---	---	-----	-------	-------

2528 Concrete Walk, Curb & Gutters

1. Curb & Gutter	m	54	_____	_____
------------------	---	----	-------	-------

2. Concrete Walks				
a. (1500mm width)(150mm thickness)	m	54	_____	_____

2547 Asphalt Tack Coat

Supply & Placement of Asphalt Tack Coat	m ²	17	_____	_____
---	----------------	----	-------	-------

2552 Hot Mix Asphalt Concrete Paving

1. Asphaltic Concrete				
1. Base Course (thickness)				
a. 50mm Thick	tonnes	339	_____	_____
2. Surface Course with anti-stripping (thickness)				
a. 50mm Thick	tonnes	341	_____	_____

2574 Reshaping & Patching Asphalt Pavement

Patching of Driveway Asphalt Pavement (<100m ²)	m ²	182	_____	_____
--	----------------	-----	-------	-------

2575 Cold Planing

m ²	17	_____	_____
----------------	----	-------	-------

2713 Water Mains

Adjust existing valve boxes to grade	ea	1	_____	_____
--------------------------------------	----	---	-------	-------

a. Sub-Total		\$ _____
b. H.S.T. 15% of a.		\$ _____
c. Grand Total (carry forward to page 1 of Bid Form)		\$ _____

Appendix "A"

TOWN OF GANDER - Street Resurfacing - Airport Boulevard - Part B

The quantities set out in this schedule are estimated quantities only and are not to be taken as final quantities by the Contractor. The unit prices bid shall include all labour, plant, materials, overhead, duties, and profit and all other obligations and liabilities under the contract. Do not include taxes in unit or lump sum prices, taxes due to be added on the last page of this schedule as indicated on the bottom. Totals shall be determined by multiplying the quantity by the tendered unit price.

SECTION	DESCRIPTION	UNIT	QUANTITY	UNIT PRICE	TOTAL
1010	Mobilization & Demobilization (not greater than 5% if on the Island or 10% if in Labrador, or 15% north of Cartwright of item as. "Sub-total" on last page)	L.S.	unit	_____	_____
1570	Traffic Regulations				
	Flagpersons Wages	Hour	96	_____	_____
	Traffic Control	L.S.	Unit	_____	_____
2547	Asphalt Tack Coat				
	Supply & Placement of Asphalt Tack Coat	m ²	3249	_____	_____
2552	Hot Mix Asphalt Concrete Paving				
	1. Asphaltic Concrete				
	1. Surface Course with anti-stripping (thickness)				
	a. 50mm Thick	tonnes	422.37	_____	_____
	2. Levelling Course	tonnes	84	_____	_____
2575	Cold Planing	m2	1746	_____	_____
2601	Manholes, Catch Basins, Ditch Inlets & Valves Chambers				
	Adjustment of Manhole/Catch Basin Frame/Cover	ea	3	_____	_____
	a. Sub-Total			\$ _____	
	b. H.S.T. 15% of a.			\$ _____	
	c. Grand Total (carry forward to page 1 of Bid Form)			\$ _____	

Appendix "A"

TOWN OF GANDER - Street Resurfacing 2024 - Rowsell Boulevard - Part C

The quantities set out in this schedule are estimated quantities only and are not to be taken as final quantities by the Contractor. The unit prices bid shall include all labour, plant, materials, overhead, duties, and profit and all other obligations and liabilities under the contract. Do not include taxes in unit or lump sum prices, taxes due to be added on the last page of this schedule as indicated on the bottom. Totals shall be determined by multiplying the quantity by the tendered unit price.

SECTION	DESCRIPTION	UNIT	QUANTITY	UNIT PRICE	TOTAL
1010	Mobilization & Demobilization (not greater than 5% if on the Island or 10% if in Labrador, or 15% north of Cartwright of item as. "Sub-total" on last page)	L.S.	unit	_____	_____
1570	Traffic Regulations				
	Flagpersons Wages	Hour	72	_____	_____
	Traffic Control	L.S.	Unit	_____	_____
2547	Asphalt Tack Coat Supply & Placement of Asphalt Tack Coat	m ²	1302	_____	_____
2552	Hot Mix Asphalt Concrete Paving				
	1. Asphaltic Concrete				
	1. Surface Course with anti-stripping (thickness)				
	a. 50mm Thick	tonnes	169	_____	_____
	2. Levelling Course	tonnes	34	_____	_____
2575	Cold Planing	m ²	649	_____	_____
2601	Manholes, Catch Basins				
	Valves Chambers				
	Adjustment of Manhole/Catch Basin Frame/Cover	ea	3	_____	_____
	a. Sub-Total			\$ _____	
	b. H.S.T. 15% of a.			\$ _____	
	c. Grand Total (carry forward to page 1 of Bid Form)			\$ _____	

**AGREEMENT BETWEEN OWNER AND CONTRACTOR
for use when a Bid Price forms the
basis of payment and to be used only
with the Contract Documents of the Contract**

THIS AGREEMENT made on the ____ day of _____ in the year two thousand and _____

BY AND BETWEEN

hereinafter called the "Owner"

AND

hereinafter called the "Contractor"

WITNESSETH: that the Owner and Contractor undertake and agree as follows:

ARTICLE 1: THE WORK

The Contractor shall:

- (a) perform all the Work required by the Contract Documents Infrastructure Upgrading 2024 – Contact #2 Street Resurfacing, which have been signed by both the parties,
- (b) do and fulfil everything indicated by this Agreement, and
- (c) commence the Work by the _____ day of _____, 20____ and substantially perform the Work of this Contract as certified by the Owner’s Representative by the _____ day of _____, 20____.

ARTICLE 2: CONTRACT DOCUMENTS

The following is an exact list of the Contract Documents referred to in Article A-1: (SEE INDEX FOR LIST OF DOCUMENTS AND DRAWINGS). **See Attached**

TABLE OF CONTENTS

	No. of Pages
Title Page	1
Specification Notice.....	1
Town of Gander OH & S Advisory Notice	1
Table of Contents	1
List of Drawings.....	1
Bid Form (Including Schedule of Quantities and Prices).....	5
Instructions to Bidders.....	18
Agreement between Owner and Contractor	5
General Conditions	33
Supplementary General Conditions	6
Supplementary Specifications.....	3
Sample Work Schedule.....	1
Certificate of Insurance	1

LIST OF DRAWINGS

INFRASTRUCTURE UPGRADING 2024 CONTRACT #2
STREET RESURFACING
Drawing #: 24-302 IFC

COVER SHEET

Sheet 1 of 6	Part A	Memorial Drive East Removal	Sta. 0+068.5 to Sta. 0+375.2
Sheet 2 of 6	Part A	Memorial Drive East Construction	Sta. 0+068.5 to Sta. 0+221.6
Sheet 3 of 6	Part A	Memorial Drive East Construction	Sta. 0+198.5 to Sta. 0+375.2
Sheet 4 of 6	Part A	Memorial Drive East Miscellaneous Details	
Sheet 5 of 6	Part B	Airport Boulevard Removal and Construction	Sta. 0+986.7 to Sta.1+192.5
Sheet 6 of 6	Part C	Rowsell Boulevard Removal and Construction	Sta. 0+938.2 to Sta.1+067.8

ARTICLE 3: CONTRACT PRICE

The Owner shall pay to the contractor in lawful money of Canada for the performance of the contract, the amounts determined for each of the items of work completed at the unit price stated in the unit price table, subject to the adjustments provided herein and in the General Conditions of the contract. The quantities contained in the unit price table are approximate only, and the final payment shall be made for the actual quantities that are incorporated in or made necessary by the work covered by the Contract.

THE CONTRACT PRICE IS \$

(HST INCLUDED) Canadian funds which price shall be subject to adjustments as may be required in accordance with the General Conditions of the Contract.

ARTICLE 4: PAYMENT

- (a) Subject to applicable legislation and, where such legislation does not exist or apply, in accordance with such prescribed regulations or industry practice respecting holdback percentages and in accordance with the provisions of the General Conditions of the Contract, the Owner shall:
 - (1) make monthly payments to the Contractor on account of the Contract Price. The amounts of such payments shall be as certified by the Owner; and
 - (2) upon Substantial Performance of the work as certified by the Owner pay to the contractor any unpaid balance of holdback monies then due; and
 - (3) upon Total Performance of the Work as certified by the Owner pay to the contractor any unpaid balance of the Contract Price then due.

- (b) If the Owner fails to make payments to the Contractor as they become due under the terms of this Contract or in any award by a court, interest at the rate and in the manner specified in GC 21-Certificates and Payments, shall become due and payable until payment. Such interest shall be calculated and added to any unpaid amounts monthly.

ARTICLE 5: ADDRESSES FOR NOTICES

All communications in writing between the parties or between them and the Owner shall be deemed to have been received by the addressee if delivered to the individual or to a member of the firm or to an officer of the Corporation for whom they are intended or if sent by post addressed as follows:

The Owner at: 100 Elizabeth Drive
 Gander, NL A1V 1G7

The Contractor at: _____

ARTICLE 6: SUCCESSION

The General Conditions of the Contract hereto annexed, and all other aforesaid Contract Documents, are all to be read into and form part of this Agreement and the whole shall constitute the Contract between the parties and subject to law and the provisions of the Contract Documents shall ensure to the benefit of and be binding upon the parties hereto, their respective heirs, legal representatives, successors and assigns.

IN WITNESS WHEREOF the parties hereto have executed this Agreement under their respective corporate seals and by the hands of their proper officers hereunto duly authorized.

SIGNED, SEALED AND DELIVERED

in the presence of:

OWNER:

CONTRACTOR

signed

signed

name and title

name and title

date

signed / witnessed

signed

name and title

name and title

date

date

N.B. Where any legal jurisdiction, local practice or client requirement calls for proof of authority to execute this document, proof of such authority in the form of a certified copy of a resolution naming the person or persons in question as authorized to sign the Agreement for and on behalf of the Corporation or Partnership, should be attached.

**GENERAL CONDITIONS
OF UNIT PRICE CONTRACT**

GENERAL CONDITIONS OF CONTRACT

INDEX	
GC 1	DEFINITIONS 1
GC 2	DOCUMENTS 3
GC 3	ADDITIONAL INSTRUCTIONS AND SCHEDULE OF WORK..... 4
GC 4	DOCUMENTS PROVIDED 4
GC 5	DOCUMENTS ON THE SITE..... 4
GC 6	OWNERSHIP OF DOCUMENTS AND MODELS 5
GC 7	OWNER'S DECISIONS..... 5
GC 8	DELAY 5
GC 9	OWNER'S RIGHT TO DO WORK..... 6
GC 10	OWNER'S RIGHT TO STOP WORK OR TERMINATE CONTRACT.. 7
GC 11	CONTRACTOR'S RIGHT TO STOP WORK OR TERMINATE CONTRACT 8
GC 12	OTHER CONTRACTORS 9
GC 13	ASSIGNMENT 9
GC 14	SUBCONTRACTORS 10
GC 15	EMERGENCIES..... 10
GC 16	SETTLEMENT OF DISPUTES AND CLAIMS..... 11
GC 17	INDEMNIFICATION 11
GC 18	CHANGES IN THE WORK..... 12
GC 19	VALUATION AND CERTIFICATION OF CHANGES IN THE WORK 12
GC 20	APPLICATION FOR PAYMENT 14
GC 21	CERTIFICATES AND PAYMENTS 14
GC 22	TAXES AND DUTIES..... 17
GC 23	LAWS, NOTICES, PERMITS AND FEES 18

GENERAL CONDITIONS OF CONTRACT

GC 24	PATENT FEES.....	19
GC 25	WORKPLACE NL.....	19
GC 26	LIABILITY INSURANCE.....	20
GC 27	PROPERTY INSURANCE	22
GC 28	PROTECTION OF WORK AND PROPERTY	24
GC 29	DAMAGES AND MUTUAL RESPONSIBILITY.....	25
GC 30	BONDS	26
GC 31	WARRANTY.....	27
GC 32	CONTRACTOR'S RESPONSIBILITIES AND CONTROL OF THE WORK	28
GC 33	SUPERINTENDENCE.....	28
GC 34	LABOUR AND PRODUCTS.....	29
GC 35	SUBSURFACE CONDITIONS	29
GC 36	USE OF PREMISES	29
GC 37	CLEANUP AND FINAL CLEANING OF WORK	30
GC 38	CUTTING AND REMEDIAL WORK	30
GC 39	INSPECTION OF WORK	31
GC 40	REJECTED WORK.....	31
GC 41	SHOP DRAWINGS	32
GC 42	SAMPLES	33
GC 43	TESTS AND MIX DESIGNS.....	33
GC 44	LABOUR	33
GC 45	TIME OF ESSENCE	34
GC 46	ASSESSMENT AND DAMAGES FOR LATE COMPLETION	34
GC 47	CERTIFICATE OF RECOGNITION FOR CONTRACTS.....	35

GENERAL CONDITIONS OF CONTRACT

GC 1 DEFINITIONS

1.1 Amendment

Modifications to the Open Call for Bids Documents identifying any required additions, deletions, clarifications or corrections.

1.2 Business Day

Any day other than a Saturday, Sunday or statutory holiday in the Province.

1.3 Contract Documents

The Contract Documents consist of the Instruction to Bidders, Electronic Bid Form, executed Agreement, General Conditions of Contract, Supplementary General Conditions of Contract, Specifications, Drawings and such other documents as are listed in Article A-2 of the Agreement, including all amendments thereto incorporated before their execution and subsequent amendments thereto made pursuant to the provisions of the contract or agreed upon between the parties. The Successful Bidder's bid, and any amendments to the Specification issued during the bidding period shall also form part of the Contract Documents.

1.4 Contract Price

The Contract Price means the amount stipulated in Article A3 of the Agreement, or as adjusted through approved changes under GC 19-VALUATION AND CERTIFICATION OF CHANGES IN THE WORK.

1.5 Contractor

The Contractor means the person, firm or corporation identified as such in the Agreement. The term Contractor means the Contractor or the Contractor's authorized representative as designated by the Contractor to the Owner in writing.

1.6 Materials and Equipment

The term Materials and Equipment means all materials, machinery, equipment and fixtures forming the completed work as required by the Contract Documents but does not include machinery and equipment used for preparation, fabrication, conveying and erection of the work and normally referred to as construction machinery and equipment.

1.7 Other Contractor

GENERAL CONDITIONS OF CONTRACT

The term Other Contractor means any person, firm or corporation employed by or having a separate contract directly or indirectly with the Owner for work other than that required by the Contract Documents.

1.8 Owner

The Owner is the person or entity identified as such in the Agreement. The term Owner means the Owner or the Owner's authorized representatives as designated by the Owner.

1.9 Owner's Representative

The Owner's Representative for the purposes of administering this construction Contract shall be the designated representative of the Owner or their consultant.

1.10 Products

The term Products means all material, machinery, equipment and fixtures forming the completed work as required by the Contract Documents but does not include machinery and equipment used for preparation, fabrication, conveying and erection of the Work and normally referred to as construction machinery and equipment.

1.11 Project

The Project is the total construction of which the Work performed under the Contract Documents may be the whole or a part.

1.12 Subcontractor

A Subcontractor is a person, firm or corporation having a direct contract with the Contractor to perform a part or parts of the Work included in the Contract, or to supply products worked to a special design according to the Contract Documents, but does not include one who merely supplies products not so worked.

1.13 Substantial Performance

A Contract shall be deemed to be substantially performed

- a) when the work or a substantial part thereof is ready for use or is being used for the purpose intended; and
- b) when the work to be done under the contract is capable of completion or correction at a cost of not more than:

GENERAL CONDITIONS OF CONTRACT

- (i) three per centum of the first two hundred and fifty thousand dollars (\$250,000) of the contract price,
- (ii) two per centum of the next two hundred and fifty thousand dollars (\$250,000) of the contract price, and
- (iii) one per centum of the balance of the contract price.

Where the work or a substantial part thereof is ready for use or is being used for the purpose intended and where the work cannot be completed expeditiously for reasons beyond the control of the contractor, the value of the work to be completed shall be deducted from the contract price in determining substantial performance.

1.14 Time

- a) The Contract Time is the time stated in Article A-1(c) of the Agreement for Substantial Performance of the Work.
- b) The date of Substantial Performance of the Work is the date certified by the Owner.
- c) The term day, as used in the Contract Documents, shall mean the calendar day.
- d) The term working day means any day observed by the construction industry in the area of the place of building.

1.15 Total Performance

Total Performance shall mean when the Work has been performed to the requirements of the Contract Documents and is so certified by the Owner.

1.16 Work

Work includes the whole of the works, materials, matters and things required to be done, furnished and performed by the Contractor under the Contract.

GC 2 DOCUMENTS

- 2.1 The Contract Documents shall be signed by the Owner and the Contractor.
- 2.2 Words which have well known technical or trade meanings are used in the Contract Documents in accordance with such recognized meanings.
- 2.3 In the event of conflicts between Contract Documents the following shall apply:

GENERAL CONDITIONS OF CONTRACT

- a) Drawings of a later date shall govern.
- b) Figured dimensions shown on the Drawings shall govern even though they may differ from scaled dimensions.
- c) Drawings of larger scale shall govern over those of smaller scale of the same date.
- d) Project Specifications shall govern over Drawings.
- e) The General Conditions of Contract shall govern over Project Specifications.
- f) Supplementary General Conditions shall govern over the General Conditions of the Contract.
- h) The Agreement Between Owner and Contractor shall govern over all documents.

GC 3 ADDITIONAL INSTRUCTIONS AND SCHEDULE OF WORK

- 3.1 During the progress of the Work the Owner may furnish to the Contractor such additional instructions as may be necessary to supplement the Contract Documents. All such instructions shall be consistent with the intent of the Contract Documents.
- 3.2 Additional instructions may include minor changes to the Work which affect neither Contract Price nor the Contract Time.
- 3.3 Additional instructions may be in the form of drawings, samples, models or written instructions.
- 3.4 Additional instructions will be issued by the Owner with reasonable promptness and in accordance with any schedule agreed upon.
- 3.5 The Contractor shall, within fifteen (15) days of the signing of this contract provide the Owner with a schedule of work.

GC 4 DOCUMENTS PROVIDED

- 4.1 The Contractor will be provided, without charge, a copy of Contract Documents or parts thereof, in electronic format, as are reasonably necessary for the performance of the Work.

GC 5 DOCUMENTS ON THE SITE

- 5.1 The Contractor shall keep one copy of all current Contract Documents and shop drawings on the site, in good order and available to the Owner and/or their

GENERAL CONDITIONS OF CONTRACT

representatives. This requirement shall not be deemed to include the executed Contract Documents.

GC 6 OWNERSHIP OF DOCUMENTS AND MODELS

- 6.1 All Contract documents and copies thereof, and all models are and shall remain the property of the Owner and are not to be used on other work.
- 6.2 Such documents are not to be revised in any manner without the written authorization of the Owner.
- 6.3 Models furnished by the Contractor or the Owner are the property of the Owner.

GC 7 OWNER'S DECISIONS

- 7.1 The Owner, in the first instance, shall decide on questions arising under the Contract Documents and interpret the requirements therein. Such decisions shall be given in writing.
- 7.2 The Contractor shall notify the Owner in writing within five (5) days of receipt of a decision of the Owner referred to in GC 7.1 if the Contractor believes that a decision by the Owner is in error and/or at variance with the Contract Documents. Unless the Contractor fulfills this requirement subsequent claims by the Contractor for extra compensation, arising out of the decision, will not be accepted.
- 7.3 If the question of error and/or variance is not resolved immediately, and the Owner decides that the disputed work shall be carried out, the Contractor shall act according to the Owner's written decision.

Any question of change in Contract Price and/or extension of Contract Time due to such error and/ or variance shall be decided as provided in GC 16 - Settlement of Disputes and Claims.

GC 8 DELAY

- 8.1 If it can be clearly shown that the Contractor is delayed in the performance of the work by any act or fault of the Owner or other Contractor, then the Contract Time shall be extended for such reasonable time as the Owner may decide in consultation with the Contractor. The Contractor shall be reimbursed for any costs incurred by the Contractor as a result of such a delay occasioned by the act or fault, provided that it can be clearly shown that the Contractor's forces cannot work efficiently elsewhere on the project and that the incurred cost is limited to that which could not reasonably have been avoided.

GENERAL CONDITIONS OF CONTRACT

- 8.2 If the Contractor is delayed in the performance of the Work by a Stop Work Order issued by any court or other public authority, and providing that such order was not issued as the result of any act or fault of the Contractor or of any one employed by the Contractor directly or indirectly, then the Contract Time shall be extended for such reasonable time as the Owner may decide, in consultation with the Contractor, and the Contractor shall be reimbursed for any on-site costs incurred by the Contractor as the result of such delay.
- 8.3 If the Contractor is delayed in the performance of the Work by civil disorders, labour disputes, strikes, lock-outs (including lock-outs decreed or recommended for its members by a recognized Contractor's Association, of which the Contractor is a member) fire, unusual delay by common carriers or unavoidable casualties or, without limit to any of the foregoing, by any cause of any kind whatsoever beyond the Contractor's control, then the Contract Time shall be extended for such reasonable time as may be decided by the Owner, in consultation with the Contractor, but in no case shall the extension of time be less than the time lost as the result of the event causing the delay, unless such shorter extension of time be agreed to by the Contractor.
- 8.4 No extension shall be made for delay unless written notice of claim is given to the Owner within fourteen (14) days of its commencement, providing that in the case of a continuing cause of delay only one notice shall be necessary.

GC 9 OWNER'S RIGHT TO DO WORK

- 9.1 If the Contractor should neglect to prosecute the Work properly or fail to perform any provisions of the Contract, the Owner may notify the Contractor in writing that the Contractor is in default of the Contractor's contractual obligations and instruct the Contractor to correct the default within five (5) working days of receiving the notice.
- 9.2 If the correction of the default cannot be completed within the five (5) working days specified, the Contractor shall be considered to be in compliance with the Owner's instructions if the Contractor:
- a) commences the correction of the default within the specified time, and
 - b) provides the Owner with an acceptable schedule for such correction, and
 - c) completes the correction in accordance with such schedule.
- 9.3 If the Contractor fails to comply with the provisions GC 9.1 and GC 9.2 the Owner may, without prejudice to any other right or remedy the Owner may have, correct

GENERAL CONDITIONS OF CONTRACT

such default and may deduct the cost thereof from the payment then or thereafter due the Contractor.

GC 10 OWNER'S RIGHT TO STOP WORK OR TERMINATE CONTRACT

10.1 If the Contractor should be adjudged bankrupt, or makes a general assignment for the benefit of creditors or if a receiver is appointed on account of the Contractor's insolvency, the Owner may, without prejudice to any other right or remedy the Owner may have, by giving the Contractor written notice, terminate the Contract.

10.2 The Owner may notify the Contractor in writing that the Contractor is in default of the Contractor's contractual obligations, if the Contractor.

- a) fails to proceed regularly and diligently with the Work; or
- b) without reasonable cause wholly suspends the carrying out of the Work before the completion thereof, or
- c) refuses or fails to supply sufficient properly skilled workers or proper quality of work, products or construction machinery and equipment for the scheduled performance of the Work within five (5) working days of receiving written notice from the Owner, except in those cases provided in GC 8 - Delay; or
- d) fails to make payments due to the Contractor's Subcontractors, suppliers or workers; or
- e) persistently disregards laws or ordinances, or the Owner's instructions; or
- f) otherwise violates the provisions of the Contract to a substantial degree.

Such written notice by the Owner shall instruct the Contractor to correct the default within five (5) working days from the receipt of the written notice.

10.3 If the correction of the default cannot be completed within the five (5) working days specified, the Contractor shall be considered to be in compliance with the Owner's instructions if the Contractor:

- a) commences the correction of the default within the specified time,
- b) provides the Owner with an acceptance schedule for such correction, and
- c) completes the correction in accordance with such schedule.

GENERAL CONDITIONS OF CONTRACT

- 10.4 If the Contractor fails to correct the default within the time specified or subsequently agreed upon, the Owner may, without prejudice to any other right or remedy the Owner may have, stop the Work or terminate the Contract.
- 10.5 If the Owner terminates the Contract under the conditions set out above, the Owner is entitled to:
- a) take possession of the premises and products and utilize the temporary buildings, plants, tools, construction machinery and equipment, goods, materials, intended for, delivered to and placed on or adjacent to the work and may complete the Work by whatever method the Owner may deem expedient but without undue delay or expense;
 - b) withhold any further payments to the Contractor until the Work is finished.
 - c) upon Total Performance of the Work, charge the Contractor the amount by which the full cost of finishing the Work including compensation to the Owner for the Owner's additional services and a reasonable allowance to cover the cost of any corrections required by GC 31 - Warranty, exceeds the unpaid balance of the Contract Price; or if such cost of finishing the Work is less than the unpaid balance of the Contract Price, pay the Contractor the difference.
 - d) on expiry of the warranty period, charge the Contractor the amount by which the cost of corrections under GC 31 - Warranty exceeds the allowance provided for such corrections, or if the cost of such corrections is less than the allowance, pay the Contractor the difference.

GC 11 CONTRACTOR'S RIGHT TO STOP WORK OR TERMINATE CONTRACT

- 11.1 If the Owner should be adjudged bankrupt, or makes a general assignment for the benefit of creditors, or if a receiver is appointed on account of the Owner's insolvency, the Contractor may, without prejudices to any other right or remedy the Contractor may have, by giving the Owner written notice, terminate the Contract.
- 11.2 If the Work should be stopped or otherwise delayed for a period of thirty (30) calendar days or more under an order of any court, or other public authority, and providing that such order was not issued as the result of any act or fault of the Contractor or of any one directly or indirectly employed by the Contractor, the Contractor may, without prejudice to any other right or remedy the Contractor may have, by giving the Owner fifteen (15) calendar days written notice, terminate the Contract.
- 11.3 The Contractor may notify the Owner in writing that the Owner is in default of the Owner's contractual obligations if:

GENERAL CONDITIONS OF CONTRACT

- a) The Owner fails to issue a certificate in accordance with GC 21 - Certificates and Payments;
- b) The Owner fails to pay to the Contractor when due any amount certified by the Owner and verified by the audit of the Owner.

Such written notice shall advise the Owner that if such default is not corrected within fifteen (15) calendar days from the receipt of the written notice the Contractor may, without prejudice to any other right or remedy the Contractor may have, stop the work and/ or terminate the contract.

- 11.4 If the Contractor terminates the Contract under the conditions set out above, the Contractor shall be entitled to be paid for all Work performed and for any loss sustained upon products and plant supplied with reasonable overhead, profit and damages.

GC 12 OTHER CONTRACTORS

- 12.1 The Owner reserves the right to let separate contracts in connection with the project of which the Work is part.
- 12.2 The Owner shall co-ordinate the work and insurance coverages of Other Contractors as it affects the Work of this Contract.
- 12.3 The Contractor shall coordinate the Contractor's work with that of Other Contractors and connect as specified or shown in the Contract Documents. Any change in the costs incurred by the Contractor in the planning and performance of such work which was not shown or included in the Contract documents as of the date of signing the Contract, shall be evaluated as provided under GC 19 - Valuation and Certification of Changes in the Work.
- 12.4 The Contractor shall report to the Owner any apparent deficiencies in other Contractor's work which would affect the Work of this Contract immediately when they come to the Contractor's attention and shall confirm such report in writing. Failure by the Contractor to so report shall invalidate any claims against the Owner by reason of the deficiencies of Other Contractor's work except as to those of which the Contractor was not reasonably aware.

GC 13 ASSIGNMENT

- 13.1 The Contractor shall not assign the Contract or any part thereof or any benefit or interest therein or thereunder with/without the written consent of the Owner.

GENERAL CONDITIONS OF CONTRACT

GC 14 SUBCONTRACTORS

- 14.1 The Contractor agrees to preserve and protect the rights of the Owner under the Contract with respect to any work to be performed under subcontract. The Contractor shall:
- a) require the Contractor's Subcontractors to perform their work in accordance with and subject to the terms and conditions of the Contract Documents, and
 - b) be fully responsible to the Owner for acts and omissions of the Contractor's Subcontractors and of persons directly or indirectly employed by them as for acts and omissions of persons directly employed by the Contractor.

The Contractor therefore agrees that the Contractor will incorporate all the terms and conditions of the Contract Documents into all Subcontract Agreements the Contractor enters into with the Contractor's Subcontractors.

- 14.2 The Contractor shall employ those Subcontractors proposed by the Contractor in writing and accepted by the Owner prior to the signing of the Contract for such portions of the work as may be designated in the bidding requirements.
- 14.3 The Owner may, for reasonable cause, object to the use of a proposed Subcontractor and require the Contractor to employ another.
- 14.4 In the event that the Owner requires a change from any proposed Subcontractor the Contract Price shall be adjusted by the difference in cost occasioned by such required change.
- 14.5 The Contractor shall not be required to employ as a Subcontractor any person or firm to whom the Contractor may reasonably object.
- 14.6 The Owner may, upon reasonable request and at the Owner's discretion, provide to a Subcontractor information as to the percentage of the Subcontractor's work which has been certified for payment.
- 14.7 Nothing contained in the Contract Documents shall create any contractual relationship between any Subcontractor and the Owner.

GC 15 EMERGENCIES

- 15.1 The Owner has authority in an emergency to stop the progress of the Work whenever in the Owner's opinion such stoppage may be necessary to ensure the safety of life, or the Work, or neighbouring property. This includes authority to make

GENERAL CONDITIONS OF CONTRACT

changes in the Work, and to order, assess and award the cost of such work, extra to the Contract or otherwise, as may in the Owner's opinion be necessary. The Owner shall, within two (2) business days, confirm in writing any such instructions. In such a case if work has been performed under direct order of the Owner, the Contractor shall keep the Contractor's right to claim the value of such work.

- 15.2 Should the Work be stopped by civil pickets, or other disorder, neither the Owner nor the Contractor shall have claim for change in the price of the Contract.
- 15.3 When requested in writing by the Owner, the Contractor shall, at no additional cost to the Owner, make appropriate alterations in the method, Product, or work force at any time the Owner considers the Contractor's actions to be unsafe, or damaging to either the Work or existing facilities or the environment.

GC 16 SETTLEMENT OF DISPUTES AND CLAIMS

- 16.1 In the case of any dispute or claim arising between the Owner and the Contractor as to their respective rights and obligations under the Contract, either party hereto may give the other written notification of such dispute or claim. The notification of dispute or claim shall be made within fourteen (14) calendar days of the dispute or cause of action arising. If the dispute or claim cannot be resolved to the satisfaction of both parties, either party may refer the matter to such judicial tribunal as the circumstances require.
- 16.2 Legal proceedings shall not take place until after the performance or the substantial performance of the disputed work except:
- a) when the dispute concerns a certificate for payment.
 - b) where either party can show that the matter in dispute requires immediate consideration while evidence is available.
 - c) in the case of legal proceedings, where the action may become prescribed by reason of delay.

GC 17 INDEMNIFICATION

- 17.1 Except as provided in GC 17.2, the Contractor shall be liable for, and shall indemnify and hold harmless the Owner against all claims, demands, losses, costs, damages, actions, suits or proceedings, whatsoever arising under any statute or Common Law:
- a) in respect of personal injury to or the death of any person whomsoever arising out of or in the course of or caused by the carrying out of the Work; and

GENERAL CONDITIONS OF CONTRACT

- b) in respect of any injury or damage whatsoever to any property, real or personal or any chattel real, insofar as such injury or damage arises out of or in the course of or by reason of the carrying out of the Work.

17.2 The Contractor shall not be liable under GC 17.1 if the injury, death, loss or damage is due to any act or neglect of the Owner.

GC 18 CHANGES IN THE WORK

18.1 The Owner may make changes by altering, adding to, or deducting from the Work, with the Contract Price and the Contract Time being adjusted accordingly.

18.2 Except as provided in GC 15 - Emergencies, no change shall be made without a written order from the Owner and no claim for an addition or deduction to the Contract Price or change in the Contract Time shall be valid unless so ordered and at the same time valued or agreed to be valued as provided in GC 19 - Valuation and Certification of Changes in the Work.

GC 19 VALUATION AND CERTIFICATION OF CHANGES IN THE WORK

19.1 The value of any change shall be determined in one or more of the following methods:

- a) by unit prices subsequently agreed upon
- b) by estimate and acceptance in a lump sum
- c) by cost and a fixed or percentage fee.

In the case of changes in the Work valued as outlined in GC 19.1 (a), where Unit Prices are provided in the Contract for Work to be done, those Unit Prices shall be used in determining the value of the change. If any Unit Price is not provided in the Contract for the Work, a Unit Price shall be subsequently agreed upon or an alternate method of determining the value of the Work shall be used.

In the case of changes in the Work valued as outlined in GC 19.1 (b), the Contractor shall submit an itemized estimate for all materials and labour to complete the extra work.

In the case of changes in the Work valued as outlined in GC 19.1 (c), the Contractor shall submit detailed invoices, vouchers and time sheets for all materials and labour to complete the extra work.

GENERAL CONDITIONS OF CONTRACT

Subject to the provisions of GC 19.2, when work is performed by the Contractor's own forces the Contractor's markup for overhead shall be ten (10) percent and the Contractor's profit ten (10) percent of the agreed or actual cost of the change. When work is performed by one of the Contractor's Subcontractors, the Subcontractor's markup for overhead shall be ten (10) percent of the agreed or actual cost of the change plus five (5) percent for profit. The Contractor's markup for overhead and profit shall be ten (10) percent of the Subcontractor's total price.

- 19.2 Notwithstanding the provisions of GC 19.1, in case of changes in the Work, (a) where unit prices are provided in the Contract for work to be done those unit prices shall be used in determining the value of any change and (b) the amount charged for equipment rentals shall be that provided in the Contract and no additional amount shall be paid as markup for overhead or profit for the Contractor or Subcontractor.
- 19.3 Notwithstanding the provisions of GC 19.1, in case of purchase of left over product or materials, the Contractor's profit shall be ten (10) percent of the cost as supported by invoices or vouchers, or agreed upon price. No markup for overhead shall be added. This applies to material or product that are supplied only and not installed on site.
- 19.4 When a change in the Work is proposed or required the Contractor shall present to the Owner for approval the Contractor's claim for any change in the Contract Price and/or change in the Contract Time. The Owner shall be satisfied as to the correctness of such claim and, when approved shall issue a written order to the Contractor to proceed with the change. The value of work performed in the change shall be included for payment with the regular certificate for payment.
- 19.5 In the case of changes in the Work to be paid for under GC 19.1, the form of presentation of costs and methods of measurement shall be agreed to by the Owner and Contractor before proceeding with the change. The Contractor shall keep accurate records, as agreed upon, of quantities or costs and present an account of the cost of the change in the Work, together with vouchers where applicable.
- 19.6 If the method of valuation, measurement and the change in Contract Price and/or change in Contract Time cannot be promptly agreed upon, and the change is required to be proceeded with then the Owner shall determine the method of valuation, measurement and the change in Contract Price and/or Contract Time subject to final determination in the manner set out in GC 16 - Settlement of Disputes and Claims. In this case the Owner shall issue a written authorization for the change setting out the method of valuation and if by lump sum the Owner's valuation of the change in Contract Price and/or Contract Time.

GENERAL CONDITIONS OF CONTRACT

- 19.7 In the case of a dispute in the valuation of a change authorized in the Work pending final determination of such value, the Owner shall certify the value of work performed and include the amount with the regular certificates for payment.
- 19.8 It is intended in all matters referred to above that both the Owner and Contractor shall act promptly.
- 19.9 Credits will be based on the net cost of material and labour or the net difference in unit price quantities.

GC 20 APPLICATION FOR PAYMENT

- 20.1 Applications for payment on account as provided for in Article A-4 of the Agreement may be made monthly as the Work progresses.
- 20.2 Application for payment shall be made monthly on a date to be agreed between the Owner and the Contractor and the amount claimed shall be for the value, proportionate to the amount of the Contract, of work performed and products delivered to the site at that date.
- 20.3 The Contractor shall submit to the Owner, before the first application for payment, a schedule of values of the various parts of the Work, aggregating the total amount of the Contract Price and divided so as to facilitate evaluation of applications for payment.
- 20.4 The revised schedule, if required, shall be made out in such form, and supported by such evidence as to its correctness, as the Owner may reasonably direct, and when approved by the Owner shall be used as the basis for application for payment.
- 20.5 When making application for payment, the Contractor shall submit a statement based upon this schedule. Claims for products delivered to the site but not yet incorporated into the Work shall be supported by such evidence as the Owner may reasonably require to establish the value and delivery of the products.
- 20.6 Applications for release of holdback monies following the Substantial Performance of the Work and the application for final payment shall be made at the time and in the manner set forth in GC 21 - Certificates and Payments.

GC 21 CERTIFICATES AND PAYMENTS

- 21.1 The Owner shall, within ten (10) days of receipt of an application for payment from the Contractor submitted in accordance with GC 20 - Application for Payment, issue a certificate for payment in the amount applied for or such other amount as

GENERAL CONDITIONS OF CONTRACT

the Owner shall determine to be properly due. If the Owner amends the application the Owner shall promptly notify the Contractor in writing, giving the Owner's reasons for the amendment.

- 21.2 The Owner shall within twenty-one (21) calendar days of the issuance of a certificate for payment by the Owner, make payment to the Contractor on account, in accordance with the provisions of the Agreement.
- 21.3 If payment is not made by the Owner within sixty (60) calendar days of issuance of a certificate for payment, the Owner will be liable for interest on the amount owing at the rate of Bank of Canada Prime rate +1 % per annum from the sixty-first (61st) day to the date of payment.
- 21.4 Notwithstanding any other provisions of this Contract:
- a) If on account of climatic or other conditions reasonably beyond the control of the Contractor there are items of work that cannot be performed, the payment in full for that which has been performed as certified by the Owner shall not be withheld or delayed by the Owner on account thereof, but the Owner may withhold from the Contract Price until the remaining work is finished an amount sufficient to cover the cost to the Owner of performing such remaining work and to adequately protect the Owner from claims.
 - b) Holdbacks will be released on the following conditions:
 - i) a copy of the contract between the Subcontractor and the Contractor, or some other suitable Document satisfactory to the Owner, must be presented to the Owner,
 - ii) the Subcontract is completed without deficiencies;
 - iii) the warranty for the Subcontract will not start until Substantial Performance of the General Contract;
 - iv) the Contractor provides an approved statutory declaration that all monies have been paid to the Subcontractors;
 - v) the Owner will, at that time, release the total amount specified on the Sub-contractor's Contract.
- 21.5 Notwithstanding the provisions of GC 21.4 (b) and notwithstanding the wording of such certificate the Contractor shall ensure that such work is protected pending the Total Performance of the Contract and be responsible for the correction of any defects in it regardless of whether or not they were apparent when such certificates were issued.

GENERAL CONDITIONS OF CONTRACT

- 21.6 The Owner shall, within ten (10) days of receipt of an application from the Contractor for a Certificate of Substantial Performance, make an inspection and assessment of the work to verify the validity of the application. The Owner shall within seven (7) days of Owner's inspection notify the Contractor of the Owner's approval or disapproval of the application. When the Owner finds the Work to be Substantially Performed the Owner shall issue such a certificate. The date of this certificate shall be the date of Substantial Performance of the Contract. Immediately following the issuance of the Certificate of Substantial Performance, the Owner, in consultation with the Contractor shall establish a reasonable date for the Total Performance of the Contract.
- 21.7 Following the issuance of the Certificate of Substantial Performance and upon receipt from the Contractor of all documentation called for in the Contract Documents the Owner shall issue a certificate for payment of holdback monies. The release of holdback monies authorized by this certificate shall become due and payable on the day following the expiration of the Statutory Limitation Period stipulated in the Mechanics' Lien Act applicable to the place of Work, providing that no lien or privilege claims against the Work exist and the Contractor has submitted to the Owner a sworn statement that all accounts for labour, subcontracts, products, construction machinery and equipment and any other indebtedness which may have been incurred by the Contractor in the Substantial Performance of the Work and for which the Owner might in any way be held responsible have been paid in full except holdback monies properly retained.
- 21.8 The Owner shall, within ten (10) days of receipt of an application from the Contractor for payment upon Total Performance of the Contract, make an inspection and assessment of the Work to verify the validity of the application. The Owner shall within seven (7) days of the Owner's inspection notify the Contractor of the Owner's approval or disapproval of the application. When the Owner finds the Work to be totally performed to the Owner's satisfaction the Owner shall issue a Certificate of Total Performance and certify for payment the remaining monies due to the Contractor under the Contract less any holdback monies which are required to be retained. The date of this certificate shall be the date of Total Performance of the Contract. The Owner shall, within thirty (30) days of issuance of such certificate, make payment to the Contractor in accordance with the provisions of Article A-4 of the Agreement.
- 21.9 The release of any remaining holdback monies shall become due and payable on the day following the expiration of the Statutory Limitation Period stipulated in the Mechanics' Lien Act applicable to the place of building or where such legislation does not exist or apply in accordance with such other legislation, regulations governing privileges, industry practice or such other provisions which may be agreed to between the parties, provided that no claims against the Work exist and the Contractor has submitted to the Owner a sworn statement that all accounts for labour, Subcontracts, products, construction machinery and equipment and any other indebtedness which may have been incurred by the Contractor in the Total

GENERAL CONDITIONS OF CONTRACT

Performance of the Work and for which the Owner might in any way be held responsible, have been paid in full except holdback monies properly retained.

21.10 No certificate for payment, or any payment made thereunder, nor any partial or entire use of occupancy of the Work by the Owner shall constitute an acceptance of any work or products not in accordance with the Contract Documents.

21.11 The issuance of the Certificate of Total Performance shall constitute a waiver of all claims by the Owner against the Contractor except those previously made in writing and still unsettled, if any, and those arising from the provisions of GC 31 - Warranty, or those arising from negligence on the part of the Contractor.

The acceptance of the Certificate of Total Performance or of the payment due thereunder shall constitute a waiver of all claims by the Contractor against the Owner except those made in writing prior to the Contractor's application for payment upon Total Performance of the Contract and still unsettled, if any.

21.12 The holdback to be used by the Owner when issuing certificate for payment will be ten (10) percent of the value of the Work completed at the date of the Contractor's claim.

21.13 Notwithstanding the provisions of GC 21.3 or any other provision of this Contract, the Owner may:

- a) in the event of a claim by the Owner against the Contractor for damages arising out of the performance or non-performance of the Contract, withhold payment of any amount equal to the alleged damages until the liability for damages is established and no amount of interest will be paid on amounts held under this clause;
- b) set-off amounts owing by the Contractor to the Owner,
- c) following the issuance of the Certificate of Substantial Performance, withhold payment of an amount equal to twice the cost, as estimated by the Owner, of remedying deficiencies until the issuance of a Certificate of Total Performance and no amount of interest will be paid on amounts held under this clause.

GC 22 TAXES AND DUTIES

22.1 The Contractor shall pay all government sales taxes, customs duties and excise taxes with respect to the Contract. All taxes and duties shall be added according to this GC.

GENERAL CONDITIONS OF CONTRACT

Contractors are advised that the Owner is not exempt from the Harmonized Sale Tax (HST). The Owner will pay the HST to the Contractor with each regular progress billing.

- 22.2 Any increase or decrease in costs to the Contractor due to changes in such taxes and duties after the date of the Agreement and up to the agreed date of completion shall increase or decrease the Contract Price accordingly. The Contractor is to co-operate with the Owner and permit access to books and records in order to establish the amount of such taxes involved.
- 22.3 The Contractor shall maintain full records of the Contractor's estimates of and actual cost to the Contractor of the Work together with all proper open call for bids, quotations, contracts, correspondence, invoices, receipts and vouchers relating thereto, shall make them available to audit and inspection by the Owner, the Auditor General for Newfoundland and Labrador or by persons acting on their behalf, shall allow them to make copies thereof and to take extracts therefrom, and shall furnish them with any information which they may require from time to time in connection with such records.

GC 23 LAWS, NOTICES, PERMITS AND FEES

- 23.1 The laws of the place of Work shall govern the Work.
- 23.2 The Contractor shall obtain all permits, licenses and certificates and pay all fees required for the performance of the Work which are in force at the date of the Open Call for Bids submission (but this shall not include the obtaining of permanent easements or rights of servitude).
- 23.3 The Contractor shall give all required notices and comply with all laws, ordinances, rules, regulations, codes and order of all authorities having jurisdiction relating to the Work, to the preservation of the public health and construction safety which are or become in force during the performance of the Work.
- 23.4 The Contractor shall not be responsible for verifying that the Contract Documents are in compliance with the applicable laws, ordinances, rules, regulations and codes relating to the Work. If the Contract Documents are at variance therewith, or changes which require modification to the Contract Documents are made to any of the laws, ordinances, rules, regulations and codes by the authorities having jurisdiction subsequent to the date of the Open Call for Bids submission, any resulting change in the cost shall constitute a corresponding change in the Contract Price. The Contractor shall notify the Owner in writing requesting direction immediately any such variance or change is observed by the Contractor.
- 23.5 If the Contractor fails to notify the Owner in writing and obtain the Owner's direction as required in GC 23.4 and performs any work knowing it to be contrary to any

GENERAL CONDITIONS OF CONTRACT

laws, ordinances, rules, regulations, codes and orders of any authority having jurisdiction, the Contractor shall be responsible for and shall correct any violations thereof and shall bear all costs, expense and damages, attributable to the Contractor's failure to comply with the Provisions of such laws, ordinances, rules, regulations, codes and orders.

- 23.6 The Contractor may be required to carry the cost of a municipal permit related to performance of the Work. If a municipal permit is requested, the Contractor shall advise the Owner of the request and where directed by the Owner, shall pay for and obtain a permit related to the conduct of the Work and the Owner will issue a change order to allow for payment of the cost of obtaining the permit. Nothing in this clause relieves the Contractor of its obligation to make such filings and to submit such documents and notices with respect to the Work on behalf of the Owner as are otherwise required by the municipality. All other permits are to remain the responsibility of the contractor.

GC 24 PATENT FEES

- 24.1 The Contractor shall pay all royalties and patent license fees required for the performance of the Contract and such royalties or fees shall be deemed to have been included in the contract price. The Contractor shall hold the Owner harmless from and against all claims, demands, losses, costs, damages, actions, suits or proceedings arising out of the Contractor's performance of the Contract which are attributable to an infringement or an alleged infringement of any patent or invention by the Contractor or anyone for whose acts the Contractor may be liable.
- 24.2 The Owner shall hold the Contractor harmless against all claims, demands, losses, costs, damages, actions, suits, or proceedings arising out of the Contractor's performance of the Contract which are attributable to an infringement or an alleged infringement of any patent or invention in executing anything for the purpose of the Contract, the model, plan or design of which was supplied to the Contractor by the Owner.

GC 25 WORKPLACE NL

- 25.1 At the time of bid submission, and prior to receiving payment on Substantial and Total Performance of the Work, the Contractor shall provide evidence of compliance with all requirements of the Province in the place of the Work with respect to worker's compensation including payments due thereunder.
- 25.2 At any time during the term of Contract, when requested by the Owner, the Contractor shall provide such evidence of compliance by the Contractor and any or all of the Contractor's Subcontractors.

GENERAL CONDITIONS OF CONTRACT

25.3 Non incorporated companies i.e.: partnerships, sole proprietorships, and independent operators must provide coverage for any employees and personal coverage for the principal(s).

GC 26 LIABILITY INSURANCE

26.1 Contractors are advised that the Bid Documents contain a Certificate of Insurance indicating the type and limit of liability (GC 26) and property insurance (GC 27) required for this project. The successful bidder will be required prior to commencement of work, to have the Certificate of Insurance completed by the Contractor's insurance company and delivered to the Owner not later than 30 days after the award of the contract. The Contractor shall not commence any work until they obtain, at their expense, all required insurances as specified on the Certificate of Insurance. Such insurance must have the approval of the Owner and be to the limits, form and amounts specified.

26.2 The Contractor's Insurance Company or its agent shall be licensed to do business in the Province of Newfoundland & Labrador.

26.3 The Contractor will not permit any Subcontractor to commence work on this Project until the same insurance requirements have been complied with by such Subcontractors.

26.4 If the Contractor should fail to effect and keep in force the policies referred to, or any other insurance which may be required to effect under the terms of the Contract, the Owner may effect and keep in force any such insurance and pay the premiums necessary for the purpose and from time to time deduct the amount so paid from any payments due to the Contractor to recover the same as a debt due from the Contractor.

26.5 Comprehensive General Liability Insurance

a) Without restricting the generality of GC 17 - Indemnification, the Contractor shall provide and maintain, either by way of a separate policy or by an endorsement to their existing policy, Commercial Liability Insurance acceptable to the Owner and subject to limits set out in detail in the Certificate of Insurance inclusive per occurrence for bodily injury, death, and damage to property including loss of use thereof.

b) This insurance shall include as an additional insured His Majesty the King in Right of Newfoundland and Labrador, the Owner, and the Occupant/Operator of the property. Such insurance must have the approval of the Owner and be to the limits, form and amounts specified. The Contractor will not permit any Subcontractor to commence work on this

GENERAL CONDITIONS OF CONTRACT

Project until the same insurance requirements have been compiled with by the Subcontractor.

- c) The insurance shall also include as Unnamed Insureds the Owner Representative of the Owner with respect to work performed by the Contractor, but excluding professional liabilities associated with such architectural and engineering consultants.
- d) The Comprehensive General Liability Insurance will not be limited to, but shall include coverage for:
 - 1) premises and operations liability
 - 2) products or completed operations liability
 - 3) blanket contractual liability
 - 4) broad form property damage
 - 5) cross liability
 - 6) elevator and hoist liability
 - 7) contingent employer's liability
 - 8) personal injury liability
 - 9) liability with respect to non-owned licensed vehicles
 - 10) shoring, blasting, excavating, underpinning, demolition, pile driving and caisson work, work below ground surface, tunneling and grading as applicable.
- e) The insurance shall include a minimum limit of \$5,000,000.00 inclusive for all claims for Bodily Injury or Property. Reduced limits for any part of the coverage is not acceptable.
- f) A deductible up to a maximum amount of \$5,000.00 will be permitted on blasting and demolition with the Contractor paying the deductible amount of each claim.
- g) Completed operations liability shall be maintained continuously until twelve (12) months from the date the Owner issues a Certificate of Substantial Performance.

26.6 Automobile Liability Insurance

- a) The Contractor shall provide and maintain liability insurance in respect of (i) owned licensed vehicles and (ii) leased vehicles, subject to limits set out in this Contract.
- b) This insurance shall include a minimum limit of \$2,000,000.00 inclusive for all claims for Bodily Injury or Property Damage arising from one accident.
- c) This insurance shall include a schedule of vehicles or a statement taken from the policy that all vehicles are covered.

GENERAL CONDITIONS OF CONTRACT

26.7 Aircraft and or Watercraft Liability Insurance

The Contractor shall provide and maintain liability insurance with respect to owned and non-owned aircraft and watercraft, as may be applicable, subject to limits set out in this Contract. Such insurance shall be in the names of the Contractor, His Majesty the King in Right of Newfoundland and Labrador, and the Owner as defined in 26.5 (b) and (c) where they have an insurable interest in the use and operation of such aircraft and watercraft.

26.8 Airport Contractor Liability Insurance

The Contractor shall provide and maintain liability insurance with respect to work completed on the tarmac side of an airport and/or inside an airport and the area outside an airport if this is not provided within the Contractor's Commercial General Liability Insurance.

26.9 Environmental Impairment Liability Insurance

a) The Contractor shall provide and maintain liability insurance with respect to environmental contamination/remediation at a work site.

b) The insurance shall include a minimum limit of \$2,000,000.00

26.10 All insurance policies shall contain an endorsement requiring notification of His Majesty the King and the Named Insured, in writing, thirty (30) days prior to cancellation of any policy or material change, except in the event of non-payment where policy conditions dealing with termination will apply.

GC 27 PROPERTY INSURANCE

27.1 The Contractor shall provide and maintain property insurance for contracts over \$25,000, acceptable to the Owner, insuring the full value of the Work in the amount of the Contract Price (excluding of HST) and the full value as stated of products for incorporation into the work. The insurance shall include as additional insured the Owner and His Majesty the King in Right of Newfoundland and Labrador.

27.2 The Contractor's Insurance Company or its agent shall be licensed to do business in the Province of Newfoundland & Labrador.

27.3 Such coverage shall be provided for by **either** Broad Form Builders' Risks Policy or an Installation Floater **or** Piers, Wharves, and Docks Rider.

27.4 The policies shall insure on a Broad Form basis direct loss or damage subject to any exclusions specified in the Contract. Such coverage shall apply to:

GENERAL CONDITIONS OF CONTRACT

- a) all products, labour, and supplies of any nature whatsoever, the property of the Insureds or of others for which the Insureds may have assumed responsibility, to be used in or pertaining to the site preparations, demolitions of existing structures, erections and/or fabrication and/or reconstruction and/or repair of the insured project, while on the site or in transit, subject to the exclusion of the property specified.
- b) the installation, testing and any subsequent use of machinery and equipment including boilers, pressure vessels or vessels under vacuum.
- c) damage to the Work caused by an accident to and/or the explosion of any boiler(s) or pressure vessel(s) forming part of the work.
- d) damage to Work caused by earthquake or flooding.

Such insurance may have a deductible clause but the amount of the deductible shall not exceed \$2,500.00.

Such coverage shall exclude construction machinery, equipment, temporary structural and other temporary facilities, tools, and supplies used in the construction of the work and which are not expendable under the Contract.

- 27.5 Policies provided shall contain an endorsement requiring notification of His Majesty the King and the Named Insured, in writing, thirty (30) days prior to cancellation of any policy or material change of coverage except in the event of non-payment where policy conditions dealing with termination will apply.
- 27.6 All such insurance shall be maintained continuously until the date the Owner issues a Certificate of Total Performance and be extended and kept in force during any Period of Delay. All such insurance shall provide for the Owner to take occupancy of the work or any part thereof during the term of the insurance. Any increase in the cost of this insurance arising out of such occupancy shall be at the Owner's expense.
- 27.7 The policies shall provide that in the event of a loss, payment for damage to the Work shall be made to the Owner and the Contractor as their respective interests may appear. The Contractor shall act on behalf of the Owner and the Contractor for the purpose of adjusting the amount of such loss with the Insurers. On the determination of the extent of the loss, the Contractor shall immediately proceed to restore the Work and shall be entitled to receive from the Owner (in addition to any sum due under the Contract) the amount at which the Owner's interest in the restoration work has been appraised, such amount to be paid as the work of restoration proceeds and in accordance with the Owner's certificates for payment. Damage shall not affect the rights and obligations of either party under the Contract

GENERAL CONDITIONS OF CONTRACT

except that the Contractor shall be entitled to such reasonable extension of time for Substantial and Total Performance of the work as the Owner may decide.

- 27.8 The Contractor shall be responsible for any deductible amounts under the policies and the payment of monies up to the deductible amount made in a satisfaction of a claim shall be borne by the Contractor.
- 27.9 The Contractor shall be responsible for providing such additional insurance as may be required to protect the insured against loss on items excluded from the policies referred to in the Contract. The provisions of the insurance coverage requirements contained in the Contract are not intended to cover all of the Contractor's obligations under GC 17 Indemnification. Any additional risk management measures or additional insurance coverages the Contractor may deem necessary to fulfill the Contractor's obligations under GC 17 shall be at the Contractor's discretion and expense.
- 27.10 The successful bidder will be required prior to commencement of work, to have the Certificate of Insurance completed by the Contractor's insurance company and delivered to the Owner not later than 30 days after the award of the contract. Such insurances must have the approval of the Owner and be to the limits, form and amounts specified. The Contractor will not permit any Subcontractor to commence work on this Project until the same insurance requirements have been complied with by the Subcontractor.
- 27.11 The interest of the Subcontractors are to be specifically included in the policy and the policy shall contain the following clause:
"Loss, if any, payable to the Owner and the Insured, as their respective interests may appear."
- 27.12 The Contractor further agrees that so much of the money due to them under and by virtue of this Contract as shall be considered necessary by the Owner may be retained by the Owner until all such suits or claims for damages shall have been settled and evidence to that effect furnished to the satisfaction of the Owner.
- 27.13 If the Contractor should fail to effect and keep in force the policies referred to, or any other insurance which may be required to effect under the terms of the Contract, the Owner may effect and keep in force any such insurance and pay the premiums necessary for the purpose and from time to time deduct the amount so paid from any payments due to the Contractor to recover the same as a debt due from the Contractor.

GC 28 PROTECTION OF WORK AND PROPERTY

- 28.1 The Contractor shall protect the property adjacent to the Project site from damage as the result of the Contractor's operations under the Contract.

GENERAL CONDITIONS OF CONTRACT

- 28.2 The Contractor shall protect the Work and the Owner's property from damage and shall be responsible for any damage which may arise as the result of the Contractor's operations under the Contract except damage which occurs as the result of:
- a) errors in the Contract Documents, and/or
 - b) acts or omissions by the Owner, the Owner's agents, employees or Other Contractors.
- 28.3 Should any damage occur to the Work and/or the Owner's property for which the Contractor is responsible, the Contractor shall make good such damage at the Contractor's own expense or pay all costs incurred by others in making good such damage.
- 28.4 Should any damage occur to the Work and/or the Owner's property for which the Contractor is not responsible as provided in GC 17 - Indemnification the Contractor shall make good such damage to the Work, and, if the Owner so directs to the Owner's property, and the Contract Price and Contract Time shall be adjusted in accordance with GC 18 - Changes in the Work.
- 28.5 The Contractor shall be completely responsible for the safety of the work as it applies to protection of the public and property and the construction of the work. All applicable Codes and Standards for the area and location of the Work shall apply to the project.
- 28.6 Any person not following the stipulated safety regulations or procedures shall be dismissed.

GC 29 DAMAGES AND MUTUAL RESPONSIBILITY

- 29.1 If either party to this Contract should suffer damage in any manner because of any wrongful act or neglect of the other party or anyone employed by that party then that party shall be reimbursed by the other party for such damages. The party reimbursing the other party shall be subrogated to the rights of the other party in respect of such wrongful act or neglect if it be that of a third party.
- 29.2 Claims under this GC shall be made in writing to the party liable within reasonable time after the first observance of such damage and not later than the time limits stipulated in GC 21 - Certificates and Payments, and may be adjusted by agreement or in the manner set out in GC 16 - Settlement of Disputes and Claims.
- 29.3 If the Contractor has caused damage to any Other Contractor on the work, the Contractor agrees upon due notice to settle with such Other Contractor by

GENERAL CONDITIONS OF CONTRACT

agreement or arbitration, if the Other Contractor will so settle. If such Other Contractor sues the Owner on account of any damage alleged to have been so sustained, the Owner shall notify the Contractor and may require the Contractor to defend the action at the Contractor's expense. If any final order or judgment against the Owner arises therefrom the Contractor shall pay or satisfy it and pay all costs incurred by the Owner.

- 29.4 If the Contractor becomes liable to pay or satisfy any final order, judgment or award against the Owner then the Contractor, upon undertaking to indemnify the Owner against any and all liability for costs, shall have the right to appeal in the name of the Owner such final order or judgment to any and all courts of competent jurisdiction.

GC 30 BONDS

- 30.1 The Owner shall have the right during the period stated in the Bid Documents for acceptance of the bid to require the Contractor to provide and maintain in good standing until the fulfillment of the Contract, bonds covering the faithful performance of the Contract including the requirements of the Warranty provided for in GC 31 - Warranty, and the payment of all obligations arising under the Contract.
- 30.2 All such bonds shall be issued by a duly incorporated surety company approved by the Owner and authorized to transact a business or surety-ship in the Province of Newfoundland and Labrador.
- 30.3 If bonds are called for in the Bid Documents or instructions to bidders, the costs attributable to providing such bonds shall be included in the bid price.
- 30.4 Should the Owner require the provision of a bond or bonds by the Contractor other than those provided for under GC 30.3, the Contract Price shall be increased by all costs attributable to providing such bonds.
- 30.5 The Contractor shall promptly provide the Owner with any bonds that are required.
- 30.6 Tender Surety and Bonding for Materials Supply Only Contracts
- .1 On contracts for supply of materials:
- a) Bid Security in the amount of 10% of the contract price and Performance Security in the amount of 50% of the contract amount is required. The Performance Security may be released 30 days after the date of substantial performance of a material supply contract.
 - b) Labour and Material Payment Security is not required.

GENERAL CONDITIONS OF CONTRACT

.2 In lieu of a Performance Bond or Bid Bond, the Minister may, at their sole discretion, approve the acceptance of a certified cheque for 10% of the tendered amount. The cheque will be deposited by the Owner until satisfactory completion of the work including the 30 day Mechanics Lien period, after which this amount will be returned to the contractor with the accrued interest thereon. There will be no limit on the value of a tender for which certified cheques may be used.

.3 No bid security or bonding will be required for the supply of vehicles or earth moving equipment.

GC 31 WARRANTY

- 31.1 Without restricting any warranty or guarantee implied or stipulated by law the Contractor shall at the Contractor's own expense rectify and make good any defect or fault however caused appearing within a period of one year from the date of Substantial Performance of the Work, unless otherwise stated in the Contract, provided that the Contractor shall not be responsible for any defect or fault resulting from the design of the Work.
- 31.2 The Contractor shall correct and/or pay for any damage to other work resulting from any corrections required under the conditions of GC 31.1.
- 31.3 Neither the Owner's final certificate nor payment thereunder shall relieve the Contractor from the Contractor's responsibility hereunder.
- 31.4 The Owner shall give the Contractor written notice of observed defects promptly.
- 31.5 In any case where the Contractor states that they are not responsible for a defect or fault because such a defect or fault is the result from a design of the work by the Owner, the onus to establish the defect or fault in the design of the work shall be on the Contractor.
- 31.6 The Contractor shall, subject to the procedures for Settlement of Disputes contained in GC 16 – Settlement of Disputes and Claims, abide by the direction and decisions of the Owner made pursuant to the General Conditions and in particular GC 7 – Owner's Decisions regarding the correction by the Contractor of any defect or fault in the work discovered during the warranty period referenced in GC 31.1 hereof.
- 31.7 The Contractor shall submit a schedule, acceptable to the Owner, for the completion of the warranty work in respect of the defect or fault referenced in GC 31.1, within thirty (30) days of the Owner requesting in writing such a schedule from the Contractor.

GENERAL CONDITIONS OF CONTRACT

- 31.8 Where the Contractor rectifies and makes good any defect or fault for which the Contractor is responsible under this Warranty, the Contractor shall warrant the portion of the work that is corrected for a period equal to the original warranty period, from the date that the correction was done.

GC 32 CONTRACTOR'S RESPONSIBILITIES AND CONTROL OF THE WORK

- 32.1 The Contractor shall have complete control of the Work except as provided in GC 15 - Emergencies. The Contractor shall effectively direct and supervise the Work using the Contractor's best skill and attention. The Contractor shall be solely responsible for all construction means, methods, techniques, sequences and procedures and for coordinating all parts of the Work under the Contract.
- 32.2 The Contractor shall have the sole responsibility for the design, erection, operation, maintenance and removal of temporary structural and other temporary facilities and the design and execution of construction methods required in their use. The Contractor shall engage and pay for registered professional engineering personnel skilled in the appropriate discipline to perform these functions where required by law or by the Contract Documents and in all cases where such temporary facilities and their method of construction are of such a nature that professional engineering skill is required to produce safe and satisfactory results.
- 32.3 Notwithstanding the provisions of GC 32.1 and GC 32.2 above, or any provisions to the contrary elsewhere in the Contract Documents where such Contract Documents include designs for temporary structural and other temporary facilities and methods shall be deemed to comprise part of the overall design of the Work and the Contractor shall not be held responsible for that part of the design or the specified method of construction. The Contractor shall, however, be responsible for the execution of such design or specified method of construction in the same manner that the Contractor is responsible for the execution of the Work.
- 32.4 The Contractor shall carefully examine the Contract Documents and shall promptly report to the Owner any error, inconsistency or omission the Contractor may discover. The Contractor shall not be held liable for any damage resulting from any such errors, inconsistencies or omissions in the Contract Documents.

GC 33 SUPERINTENDENCE

- 33.1 The Contractor shall employ a competent superintendent and necessary assistants who shall be in attendance at the Work site at all times while work is being performed.

GENERAL CONDITIONS OF CONTRACT

- 33.2 The superintendent shall be satisfactory to the Owner and shall not be changed except for good reason and only then after consultation with and agreement by the Owner.
- 33.3 The superintendent shall represent the Contractor at the Work site. Directions given to the superintendent by the Owner shall be held to have been given to the Contractor. Important directions shall be confirmed to the Contractor in writing, other directions will be so confirmed if requested.

GC 34 LABOUR AND PRODUCTS

- 34.1 Unless otherwise stipulated elsewhere in the Contract Documents, the Contractor shall provide and pay for all labour and products, tools, construction equipment and machinery, water, heat, light, power, transportation and other facilities and services necessary for the proper performance of the Work.
- 34.2 All products provided shall be new unless otherwise specified in the Contract Documents. Any products which are not specified shall be of a quality best suited to the purpose required and their use subject to the approval of the Owner.
- 34.3 The Contractor shall at all times maintain good order and discipline among the Contractor's employees engaged on the Work and shall not employ on the Work any unfit person nor anyone not skilled in the task assigned to that person.

GC 35 SUBSURFACE CONDITIONS

- 35.1 The Contractor shall promptly notify the Owner in writing if, in the Contractor's opinion, the subsurface conditions at the Project site differ materially from those indicated in the Contract Documents or as may have been represented to the Contractor by the Owner before the time of Open Call for Bids submission.
- 35.2 After prompt investigation, should the Owner determine that conditions do differ materially, the Owner shall issue appropriate instructions for changes in the Work as provided for in GC 18 - Changes in the Work.

GC 36 USE OF PREMISES

- 36.1 The Contractor shall confine the Contractor's apparatus, the storage of products and the operations of the Contractor's workers to limits indicated by laws, ordinances, permits or by directions of the Owner and shall not unreasonably encumber the premises with the Contractor's products.

GENERAL CONDITIONS OF CONTRACT

- 36.2 The Contractor shall not load or permit to be loaded any part of the Work with a mass that will endanger its safety.
- 36.3 The Contractor shall enforce the Owner's instructions regarding signs, advertisements, fires and smoking.
- 36.4 Unless otherwise provided the Contractor shall, at the Contractor's own expense, and without extra cost to the Owner, make suitable provision to accommodate all traffic either pedestrian or vehicular, over or around, the project upon which work is being performed, in a manner satisfactory to the Owner.
- 36.5 The Contractor shall provide and maintain at the Contractor's own expense such fences, barriers, signs, lights and security as may be necessary to prevent avoidable accidents to residents or to the public generally.

GC 37 CLEANUP AND FINAL CLEANING OF WORK

- 37.1 The Contractor shall maintain the Work in a tidy condition and free from the accumulation of waste products and debris, other than that caused by the Owner, other Contractors or their employees.
- 37.2 When the Work is Substantially Performed the Contractor shall remove all of the Contractor's surplus products, tools, construction machinery and equipment not required for the performance of the remaining work. The Contractor shall also remove any waste products and debris and leave the Work clean and suitable for occupancy by the Owner unless otherwise specified.
- 37.3 When the Work is Totally Performed, the Contractor shall remove all of the Contractor's surplus Products, tools, construction machinery and equipment. The Contractor shall also remove any waste products and debris, other than that caused by the Owner, other Contractors or their employees.

GC 38 CUTTING AND REMEDIAL WORK

- 38.1 The Contractor shall do all cutting and remedial work that may be required to make the several parts of the Work come together properly.
- 38.2 The Contractor shall co-ordinate the schedule for the Work to ensure that this requirement is kept to a minimum.
- 38.3 Should the Owner or anyone employed by the Owner be responsible for ill-timed work necessitating cutting and/or remedial work shall be valued as provided in GC 19 Valuation and Certification of Changes in the Work and added to the Contract Price.

GENERAL CONDITIONS OF CONTRACT

38.4 Cutting and remedial work shall be performed by specialists familiar with the materials affected and shall be performed in a manner to neither damage nor endanger any Work.

GC 39 INSPECTION OF WORK

39.1 The Owner and the Owner's authorized representatives shall have access to the Work for inspection wherever it is in preparation or progress. The Contractor shall co-operate to provide reasonable facilities for such access.

39.2 If special tests, inspections or approvals are required by the Contract Documents, the Owner's instructions or the laws or ordinances of the place of building the Contractor shall give the Owner timely notice requesting inspection. Inspection by the Owner shall be made promptly. The Contractor shall arrange inspection by other authorities and shall notify the Owner of the date and time.

39.3 If the Contractor covers or permits to be covered any of the Work that is subject to inspection or before any special tests and approvals are completed without the approval of the Owner, the Contractor shall uncover the Work, have the inspection satisfactorily completed and make good the Work at the Contractor's own expense.

39.4 Examination of any questioned Work may be ordered by the Owner. If such Work be found in accordance with the Contract the Owner shall pay the cost of examination and replacement, together with the cost of subsequent verification testing. If such Work be found not in accordance with the Contract through the fault of the Contractor, the Contractor shall pay such cost.

39.5 The Contractor shall furnish promptly to the Owner all certificates and inspection reports relating to the Work.

GC 40 REJECTED WORK

40.1 Defective Work, whether the result of poor workmanship, use of defective products or damage through carelessness or other act or omission of the Contractor, and whether incorporated in the Work or not, which has been rejected by the Owner as failing to conform to the Contract Documents shall be removed promptly from the premises by the Contractor and replaced and/or executed promptly in accordance with the Contract Documents at the Contractor's expense.

40.2 Other Contractor's work destroyed or damaged by such removals or replacements shall be made good promptly at the Contractor's expense.

GENERAL CONDITIONS OF CONTRACT

40.3 If in the opinion of the Owner it is not expedient to correct defective work not done in accordance with the Contract Documents, the Owner may deduct from the Contract Price the difference in value between the Work as done and that called for by the Contract, the amount of which shall be determined in the first instance by the Owner.

GC 41 SHOP DRAWINGS

41.1 The term "shop drawings" means drawings, diagrams, illustrations, schedules, performance charts, brochures, and other data which are to be provided by the Contractor to illustrate details of a portion of the Work.

41.2 The Contractor shall arrange for the preparation of clearly identified shop drawings as called for by the Contract Documents or as the Owner may reasonably request.

41.3 Prior to Submission to the Owner the Contractor shall review all shop drawings. By this review the Contractor represents that the Contractor has determined and verified all field measurements, field construction criteria, materials, catalogue numbers and similar data or will do so and that the Contractor has checked and coordinated each shop drawing with the requirements of the Work and of the Contract Documents. The Contractor's review of each shop drawing shall be indicated by stamp, date and signature of a responsible person.

41.4 The Contractor shall submit shop drawings to the Owner for the Owner's review with reasonable promptness and in orderly sequence so as to cause no delay in the Work or in the Work of Other Contractors. If either the Contractor or the Owner so requests they shall jointly prepare a schedule fixing the dates for submission and return of shop drawings. Shop drawings shall be submitted in electronic format (PDF) or prints as the Owner may direct. At the time of submission the Contractor shall notify the Owner in writing of any deviations in the shop drawings from the requirements of the Contract Documents.

41.5 The Owner will review and return shop drawings in accordance with any schedule agreed upon, or otherwise with reasonable promptness so as to cause no delay. The Owner's review shall be for conformity to the design concept and for general arrangement only and such review shall not relieve the Contractor of responsibility for errors or omissions in the shop drawings or of responsibility for meeting all requirements of the Contract Documents unless a deviation on the shop drawings has been approved in writing by the Owner.

41.6 The Contractor shall make any changes in shop drawings which the Owner may require consistent with the Contract Documents and resubmit unless otherwise directed by the Owner. When resubmitting the Contractor shall notify the Owner in writing of any revisions other than those requested by the Owner.

GENERAL CONDITIONS OF CONTRACT

GC 42 SAMPLES

- 42.1 The Contractor shall submit for the Owner's approval such standard manufacturers' samples as the Owner may reasonably require. Samples shall be labelled as to origin and intended use in the Work and shall conform to the requirements of the Contract Documents.
- 42.2 The Contractor shall provide samples of special products, assemblies, or components when so specified. The cost of such samples not specified shall be authorized as an addition to the Contract Price as provided in GC 18 - Changes in the Work.

GC 43 TESTS AND MIX DESIGNS

- 43.1 The Contractor shall furnish to the Owner test results and mix designs as may be requested. The testing company must first be approved by the Owner.
- 43.2 The cost of tests and mix designs beyond those called for in the Contract Documents or beyond those required by laws, ordinances, rules and regulations relating to the work and the preservation of public health, shall be authorized as an addition to the Contract Price as provided in GC 18 - Changes in the Work.

GC 44 LABOUR

- 44.1 In carrying out the Contractor's duties under this contract, the Contractor shall comply with all Provincial and Federal legislation respecting labour and the employment of labour, where applicable, including the labour standards code and shall not operate in conflict with the Human Rights legislation. In the employment of labour, preference should be given to persons normally resident in Newfoundland and Labrador.
- 44.2 The Contractor and Subcontractors shall maintain and keep available for inspection by the Owner, a record of the names and addresses of all workers employed on the Project.
- 44.3 All Work shall be done by workers skilled in their various trades.
- 44.4 There shall be no discrimination in the selection of workers for employment on the project in respect of gender, race, religious views or political affiliation.
- 44.5 The Contractor shall pay fair wages and shall pay rates of wages and allowances to the various classes of labour not less favourable than those prevailing in the area where the Work is being performed.

GENERAL CONDITIONS OF CONTRACT

44.6 The Contractor shall ensure that all employees (including owners, management, and subcontracted employees) are aware that workplace violence and harassment will not be tolerated. Allegations of workplace violence and harassment perpetrated against employees of the Department of Transportation and Infrastructure will be investigated and addressed as per the Department of Transportation and Infrastructure's Workplace Violence and Harassment Prevention Program, and may result in correction actions aimed at individuals or the Contractor. The Contractor hereby agrees to be bound by the Department of Transportation and Infrastructure's Workplace Violence and Harassment Prevention Program and shall cooperate fully in any resulting investigations and shall ensure compliance with any subsequent corrective actions.

GC 45 TIME OF ESSENCE

45.1 Time is of the essence of the Contract.

GC 46 ASSESSMENT AND DAMAGES FOR LATE COMPLETION

46.1 For purposes of this General Condition

- a) The Work shall be deemed to be completed on the date that a Certificate of Substantial Performance referred to in GC 21.6 is issued, and
- b) "Period of delay" means the number of days commencing on the day fixed by the Articles of Agreement for completion of the Work and ending on the day immediately preceding the day on which the Work is completed but does not include any day in which, in the opinion of the Owner, completion of the Work was delayed for reasons beyond the control of the Contractor.

46.2 If the Contractor does not complete the Work by the day fixed for its completion by the Articles of Agreement but completes it thereafter, the contractor shall pay the Owner an amount equal to the aggregate of

- a) all salaries, wages and travelling expenses incurred by the Owner in respect of persons overseeing the performance of the Work during the period of delay, and
- b) all other expenses and damages incurred or sustained by the Owner during the period of delay as a result of the Work not being completed by the day fixed for its completion.

46.3 Substantial Performance of part of the work shall not relieve the Contractor of their liabilities under this clause.

GENERAL CONDITIONS OF CONTRACT

GC 47 CERTIFICATE OF RECOGNITION FOR CONTRACTS

- 47.1 The Contractor shall, at the time of bid submission, submit a Letter of Good Standing stating Certificate of Recognition (COR) certified from the Newfoundland and Labrador Construction Safety Association (NLCSA), or equivalent. The Letter of Good Standing stating COR Certified must be valid at the Submission Deadline (Closing Date).
- 47.2 At any time during the term of the Contract, when requested by the Owner, the Contractor shall provide such evidence of compliance by any or all of their Subcontractors.

SUPPLEMENTARY GENERAL CONDITIONS

SGC 1.0 - LIQUID ASPHALT COST ADJUSTMENT

- (a) Adjustments will be made to progress estimates to compensate for changes in liquid asphalt prices at time of tender and prices in effect during construction. Increases or decreases in excess of 5% of the Benchmark Tender Price will be paid or deducted accordingly. The governing price will be the average price quoted by local suppliers on the 20th of each month for the Holyrood and Come by Chance Terminals. This adjustment will include any changes in taxes outlined in GC 22.2.
- (b) The benchmark price shall be the most recent price published on Municipal Infrastructure's website, under MI Liquid Asphalt and Petroleum Cost Adjustment at time of tender close. The adjustments shall be computed based on changes in the average monthly price in excess of or less than this benchmark at time of production. The Owner shall then calculate the adjustment to be stated in the Monthly Progress Estimates.
- (c) The liquid asphalt cost adjustment shall be calculated using the quantity of the item added to the progress estimate since the last estimate. In cases where liquid asphalt is included in the price of Asphalt Concrete, the liquid asphalt quantity will be determined using the mix design.

SGC 2.0 - FEDERAL/PROVINCIAL FUNDED PROJECTS

For Federal/Provincial funded projects the following should apply:

- (a) No former Federal public office holder who is not in compliance with the post-employee code for public office holders shall be permitted to benefit on this project.
- (b) No member of the House of Commons or Senate of Canada or the House of Assembly of Newfoundland & Labrador shall be permitted to benefit on this project.
- (c) His Majesty the King in right of Canada shall be added as an additional named insured in GC 26 and GC 27.

SGC 3.0 - PETROLEUM PRODUCTS COST ADJUSTMENT

Adjustment will be made to progress estimates to compensate for changes in fuel prices at time of tender closing and prices in effect during construction. Increases or decreases in excess of 10% of the Benchmark Tender Price will be paid or deducted accordingly. The governing price will be the most recent price, for the zone in which the majority of the contract is being carried out, established by the

SUPPLEMENTARY GENERAL CONDITIONS

Petroleum Products Pricing Commissioner at time of tender close. This adjustment will include any changes in taxes outlined in GC 22.2.

The adjustment for fuel cost variation shall apply only to those items given in the accompanying list. For other tender items, there will be no fuel cost adjustments.

The benchmark price shall be the price established by the Petroleum Products Pricing Commissioner at time of tender. The adjustments shall be computed based on changes in the monthly price in excess of or less than this benchmark at time of production. The Owner's Representative shall then calculate the adjustment to be stated in the Monthly Progress Estimate.

For the contract items included in the accompanying list, the fuel cost adjustment shall be calculated using the quantity of the item added to the progress estimate since the last estimate.

The fuel cost adjustment shall be credited to, or debited from, the progress estimate depending on whether the prices during construction are higher than, or less than, the benchmark at time of tender closing.

- a) Mass Excavation Common Material shall include: site work and grading; excavation, trenching and backfilling; and roadway excavation, embankment and compaction.
- (b) Mass Excavation Solid Rock shall also include: Ditching Solid Rock; Quarried Rock; Rock Fill in Place including Armour Stone; and Excavation for Foundation Solid Rock.
- (c) If the granular material or asphalt aggregate is produced from a rock quarry source, an additional 1.0 L/t of clear diesel fuel will be added to the quantity shown in the table.

Contract Item	NOMINAL FUEL CONSUMPTION RATE (litres)		
	Clear Diesel Fuel	Furnace Oil	Marked Diesel Fuel
Mass Excavation Common & Imported Common	2.0 L/m ³	N/A	N/A
Mass Excavation Solid Rock	4.0 L/m ³	N/A	N/A
Trench Excavation: Common Material	5.0 L/m ³	N/A	N/A
Trench Excavation: Rock	10.0 L/m ³	N/A	N/A
Granular Material	1.0 L/t	N/A	1.0L/t
Asphaltic, Base Surface & Levelling Courses	1.0 L/t	11.0L/t	2.0L/t

SUPPLEMENTARY GENERAL CONDITIONS

	NOMINAL FUEL CONSUMPTION RATE (litres)		
Armour Stone Excavation	4.0 L/m ³	N/A	N/A

SGC 4.0 CERTIFICATE FOR PAYMENT

In reference to GC 21, the sixty (60) day interest free period for payments starts the day after a mutually acceptable application for payment has been submitted by the Contractor.

SGC 5.0 - PROJECT DURATION

A Working Day shall be defined as ten (10) hours.

The estimated contract value must include cost of materials supplied under separate contracts.

The table below is a guide for determining Working Hours for Water and Wastewater projects only. The Owner reserves the right to alter the schedule to meet their needs.

For other project types, this table may or may not be referenced.

The Owner will base the allowable number of Working Days to substantially perform the project by the following table or an interpolation thereof:

Estimated Contract Value	Working Hours (Days) (for Substantial Performance)
0 to 150,000	220 (22)
500,000	450 (45)
1,000,000	740 (74)
1,500,000	940 (94)
2,000,000	1120 (112)
2,500,000	1220 (122)
3,000,000	1350 (135)
3,500,000	1480 (148)
4,000,000	1570 (157)

Should the final tender value differ from the estimate, there will be no allowance to change the working hours.

SGC 6.0 – Builder’s Risk Insurance

SUPPLEMENTARY GENERAL CONDITIONS

In reference to GC 27, Builder's Risk insurance is only required where a structure (i.e. building) is being newly constructed or renovated. The requirement for Builder's Risk insurance is outlined in the Insurance Form.

The value of the coverage for the Builder's Risk Insurance is the total value of the completed structure, including materials.

SGC 7.0 – As-Builts

In reference to GC 1.13 Substantial Performance, GC 21 Certificates and Payments, and Section 01720, the recording of the as-built conditions are required to be submitted for review prior to the issuance of the Substantial Performance Certificate. This forms part of the requirement to be deemed substantially performed.

Town of Gander

Supplementary Specifications Infrastructure Upgrading 2024 Contract #2 Street Resurfacing/Upgrades

GENERAL PROJECT DESCRIPTION

- .1 This contract generally consists of but is not limited to the supply of all labour, plant and materials necessary to complete upgrading and paving of Part A - Memorial Drive East from Cooper Boulevard to Old Navy Road, Part B – resurfacing of Airport Boulevard from Memorial Drive to the entrance of 120 Airport Boulevard & Part C - resurfacing of Rowsell Boulevard from Intersection of Russell Street to 90 Rowsell Boulevard. Complete street upgrading/resurfacing in various locations throughout town
- .2 The site of work is at Gander, Newfoundland.

1. SCOPE OF WORK

- .1 Part A - Upgrade a section of Memorial Drive East for a distance measuring approximately 300 metres. Work consists of removal and replacement of a culvert, ditching, clearing and mass excavation, supply and place rock base and granular subgrade material, and asphalt for street widening and reinstatement.
- .2 Part B -Mill and pave a section of Airport Boulevard between Memorial drive and 120 Airport Boulevard. Associated work including but not limited to MH/CB frame and cover/grate adjust to grade.
- .2 Part C - Mill and pave a section of Rowsell Boulevard between Russell Street and 90 Rowsell Boulevard. Associated work including but not limited to MH/CB frame and cover/grate adjust to grade.

2. DISPOSAL SITE

- .1 The contractor is responsible for:
 - .1 The trucking and disposal of all excess waste materials removed from the site to an approved site provided by the contractor.
 - .2 Asphalt shall be loaded in trucks separate from other materials and delivered to an approved site provided by the contractor.
 - .3 The owner may wish to retain milled asphalt. If determined at the time of the work the contractor shall truck to a site a determined by the on-site engineer and shall be dumped in a manner for easy grading by others. The location selected will be within 7.0km of the construction site. If the town is unable to accept this material, it shall be deemed as excess waste material.
 - .4 Any cost for this item is to be included in unit prices for applicable items in the Schedule of Quantities and Prices.

3. COLD PLANING (Milling)

- .1 Cold milling shall be completed using equipment and methods as indicated in the specifications.
- .2 In addition to the areas specifically identified on the plan, the on-site engineer may indicate areas that require cold milling. In general, the high points between the tire ruts in the high traffic lanes will be milled to reduce the amount of levelling course asphalt required as well as reduce the overall elevation of the road.

Town of Gander

Supplementary Specifications Infrastructure Upgrading 2024 Contract #2 Street Resurfacing/Upgrades

4. ASPHALT PAVING

- .1 Surface course asphalt shall include an anti-stripping agent.
- .2 Patching for road work shall include 50 mm of base course asphalt. Granular Base materials shall be paid by the Tonne and quantities are included in the unit price table.
- .3 Asphalt cutting is included in the cost for asphalt removal as per section 2574 subsection 3.2.1 of the Municipal Water Sewer and Roads Master Construction Specification and will not be paid as a separate item.
- .4 Prior to the placement of any surface course asphalt on any asphalt other than new, the entire area shall be swept using an approved vacuum sweeper truck which applies water ahead of the brooms. Sweeping shall be repeated until the surface is clear of all fines and the on-site representative approves the area ready for the application of the Tac-Coat.

5. MANHOLE AND CATCHBASIN FRAME AND COVER/GRATE

- .1 All catch basins and manholes to have a minimum of one 50 mm thick grade rings to be used to adjust the frame and cover/grate to the required grade. If the manhole/catch basin is located in the driving area, in addition to the concrete grade rings a minimum 25 mm thick HDPE ring must be placed directly beneath the frame and cover/grate. These HDPE grade rings are to be tapered to suit the profile of the slope of road.
- .2 The finished elevation of all catch basin frames and grates to be 25 mm below the adjacent asphalt grade. Asphalt shall be tapered to the frame for a distance of 1.5 meters.

6. SCHEDULING OF WORK

Due to the high volume of traffic on these sections of roadway, extra precautions will have to be in place to ensure traffic flows operate with minimal disruption and businesses, schools can have continued access without interruption during their normal operating hours. This may involve scheduling of work in specific areas either earlier or later in the day and on Sunday.

Work must be coordinated so that both sides of the road, within a 60m distance, are not simultaneously disrupted. At the end of the working day the road must be useable in both directions.

Due to local conditions the contractor may be required to initiate a road closure. Any required or requested closure by the contractor shall be submitted in writing in the form of a schedule to the Consultant. Such request shall be made at least one week in advance of the requested closure. The contractor shall adhere to approved schedule and provide notice to affected parties. Refer to the appropriate sections in the Master Specifications.

7. READY MIXED CONCRETE

Contractors are advised that the Town of Gander will only accept "Cast-in Place" concrete which has been produced by a facility that supplies Ready Mixed Concrete. Volumetric mixing trucks, commonly referred to as on site concrete, will not be permitted to supply concrete for municipal infrastructure work.

Town of Gander

Supplementary Specifications Infrastructure Upgrading 2024 Contract #2 Street Resurfacing/Upgrades

8. DUST CONTROL

The contractor shall be responsible for dust control on the entire job site. Work area to be maintained in a manner to reduce the amount of dust being created causing a nuisance to areas residents and motorists. The contractor shall sweep asphalt surfaces on a daily basis as a minimum or more frequently as directed by the owner's on-site representative. Any cost associated with sweeping or the application of water only is to be included in the unit costs of the schedule of quantities and prices.

9. CONTRACT DOCUMENTATION

Within fourteen (14) days after notification, in writing, of acceptance of the tender, the contractor shall supply to the Owner the following documentation

- .1 Performance Bond
- .2 Labour Materials Payment Bond
- .3 Copy of Insurance Certificate
- .4 Copy of COR Certification
- .5 Certificate of Clearance from WorkplaceNL
- .6 Completed Contractor Health and Safety Questionnaire
- .7 Completed Contractor Orientation Acknowledgement Form
- .8 Completed Pre-work Hazard Assessment
- .9 Completed Work Schedule indicating specific start and end dates for individual milestones of major portions of the work.

Upon receipt of all required documentation, contract documents will be prepared and sent to the contractor for signing.

CERTIFICATE OF INSURANCE

DESCRIPTION & LOCATION OF WORK				
PROJECT NO:		AWARD DATE:		VALUE:
INSURER:				
INSURER ADDRESS:				
BROKER:				
BROKER ADDRESS:				
INSURED NAME OF CONTRACTOR:				
CONTRACTOR ADDRESS:				
ADDITIONAL INSURED (Excluding Automobile Liability Policy) <input checked="" type="checkbox"/> The OWNER: <input checked="" type="checkbox"/> "His Majesty the King in Right of the Province of NL as represented by the Minister of Transportation & Infrastructure. Dept. of Transportation & Infrastructure, P.O. Box 8700, St. John's, NL., A1B 4J6, Attn: Tendering & Contracts <input checked="" type="checkbox"/> The Occupant/Operator of the Property: <input checked="" type="checkbox"/> Owner's Representative of the OWNER (excluding professional liabilities)				
ADDITIONAL INSURED FOR FEDERAL FUNDED PROJECTS (where applicable) <input type="checkbox"/> His Majesty the King in Right of Canada				
This document certifies that the following policies of insurance and indicated coverage are at present in force subject to the terms, conditions and exclusions as contained therein covering the operations of the insured in connection with the above noted contract made between the named insured and the Owner.				
POLICY TYPE	POLICY NUMBER	INCEPTION DATE	EXPIRY DATE Y/M/D	LIMITS OF LIABILITY
1.1 COMMERCIAL GENERAL LIABILITY or 1.2 WRAP-UP LIABILITY (Including where indicated) A. BLASTING B. PILE DRIVING OR CAISSON WORK C. REMOVAL OR WEAKENING OF SUPPORT				\$5,000,000 Minimum
2A. BUILDERS' RISK "BROAD FORM" or 2B. INSTALLATION FLOATER "BROAD FORM" or 2C. PIERS, WHARVES, & DOCKS RIDER				100% Contract Value of structure if Exceeds \$25,000
3. AUTOMOBILE LIABILITY INSURANCE				\$2,000,000 Minimum
4. AIRCRAFT AND/OR WATERCRAFT WATERCRAFT LIABILITY (IF APPLICABLE)	Not required			\$2,000,000 Minimum
5. AIRPORT CONTRACTOR LIABILITY	Not required			\$5,000,000.00 Minimum
6. ENVIRONMENTAL IMPAIRMENT LIABILITY				\$2,000,000.00 Minimum
The Insurer agrees to notify the Owner and His Majesty, as defined above, in writing, thirty (30) days prior to cancellation, termination or material change of any policy.				
NAME OF INSURER'S OFFICER or AUTHORIZED REPRESENTATIVE :	SIGNATURE:		Date:	
			Tel.:	
			Email:	
Issuance of this certificate shall not limit or restrict the right of the Owner to request at any time duplicate certified copies of said insurance policies.				

INFRASTRUCTURE UPGRADING 2024

CONTRACT #2

STREET RESURFACING

24-302



TITLE SHEET

- 24-302-1 **MEMORIAL DRIVE EAST REMOVAL**
(Sta. 0+068.5 to Sta. 0+375.2)
- 24-302-2 **MEMORIAL DRIVE EAST CONSTRUCTION**
(Sta. 0+069.1 to Sta. 0+221.6)
- 24-302-3 **MEMORIAL DRIVE EAST CONSTRUCTION**
(Sta. 0+198.5 to Sta. 0+375.2)
- 24-302-4 **MEMORIAL DRIVE EAST CONSTRUCTION**
MISCELLANEOUS DETAILS
- 24-302-5 **AIRPORT BOULEVARD**
REMOVAL AND CONSTRUCTION
(Sta. 0+986.7 to Sta. 1+192.5)
- 24-302-6 **ROWSELL BOULEVARD**
REMOVAL AND CONSTRUCTION
(Sta. 0+938.2 to Sta. 1+067.8)

TOWN OF GANDER
Department of Engineering
100 Elizabeth Drive, Gander, NL A1V 1G7

PLEASE NOTE: THESE PROJECT DOCUMENTS HAVE BEEN PREPARED FOR USE WITH, AND REQUIRE BEING READ IN CONJUNCTION WITH THE *STANDARD SPECIFICATION FOR MUNICIPAL SERVICES* AS PUBLISHED BY THE PROVINCE OF NEWFOUNDLAND & LABRADOR, DEPARTMENT OF MUNICIPAL AFFAIRS AND ENVIRONMENT

Town of Gander Tender #:
OC-24-08

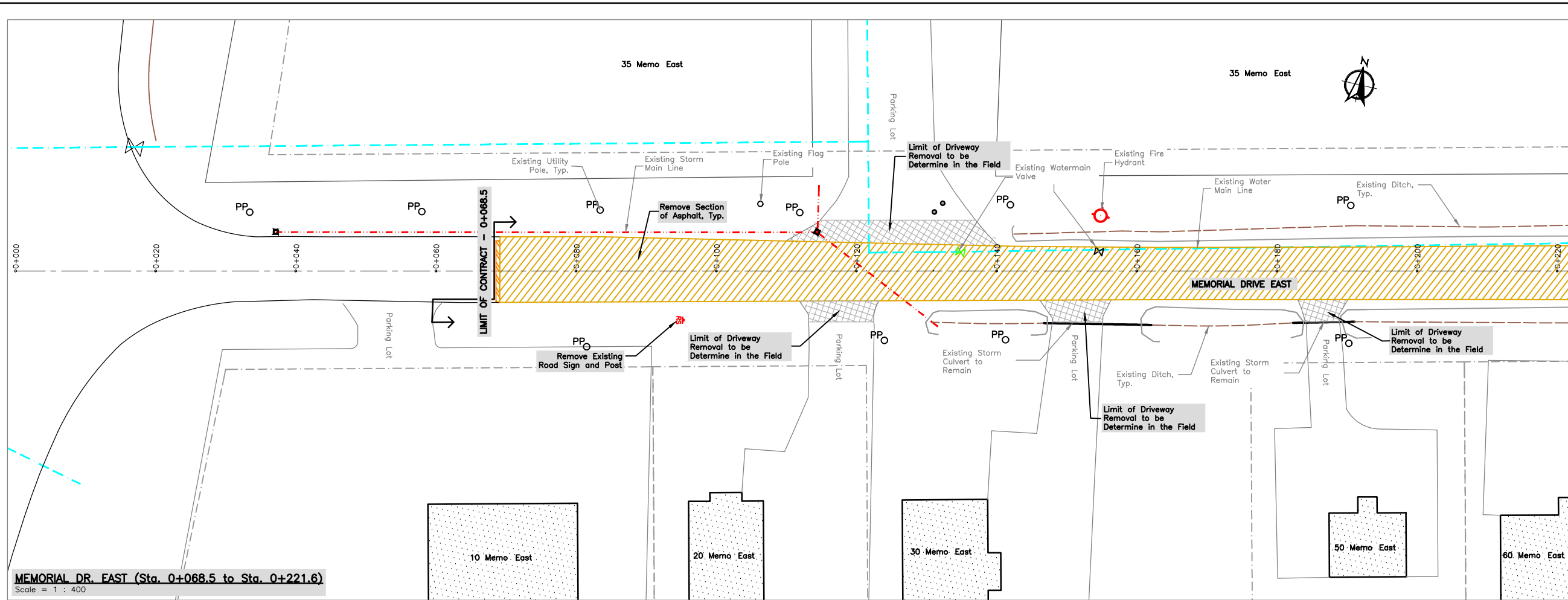

MEMORIAL DR. EAST (Sta. 0+068.5 to Sta. 0+221.6)
Scale = 1 : 400

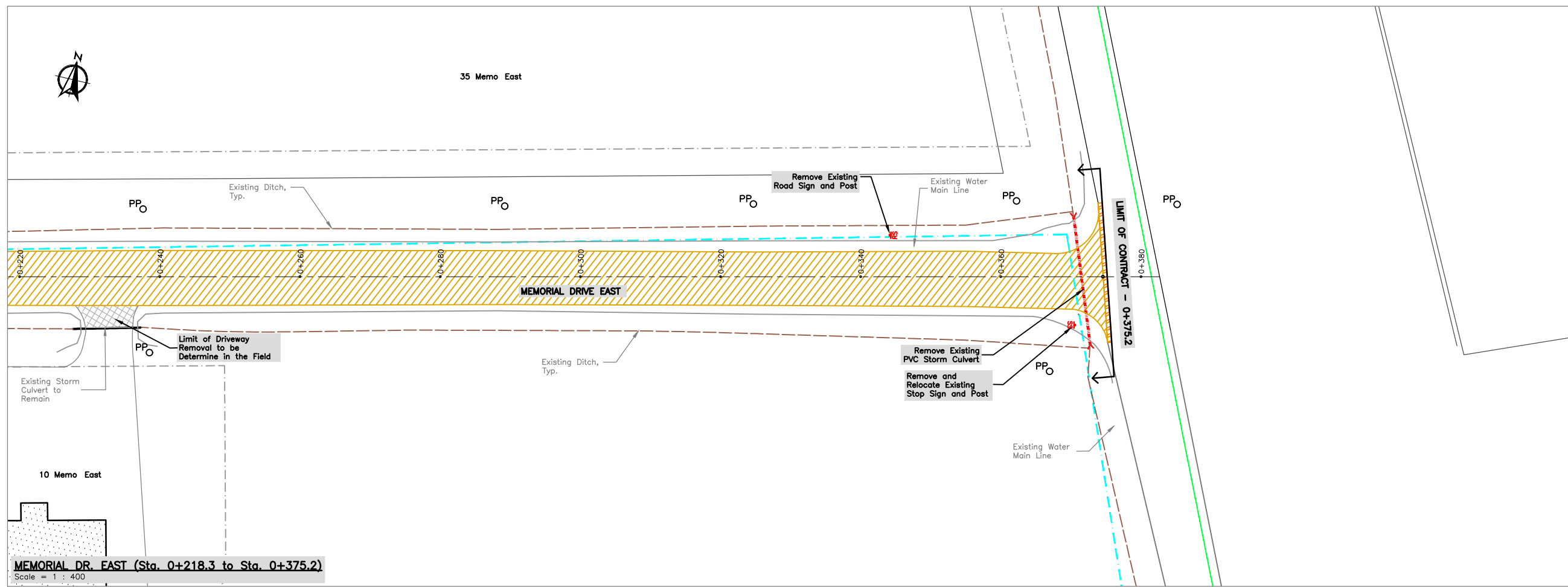

MEMORIAL DR. EAST (Sta. 0+218.3 to Sta. 0+375.2)
Scale = 1 : 400

NOTES

1. Unless otherwise noted, all dimensions are in meters.
2. All roadway asphalt within the limits of construction is to be removed.
3. Contractor will be required to provide class "A" ramps, as required, immediately upon completion of removals.
4. Limits of removal indicated for landscaping and driveway asphalt are approximate only. Exact limit to be determined in the field based on drainage and slope considerations.
5. Road sign definition, RS--road sign, SS--stop sign.

—LEGEND—

- Existing Watermain
- Existing Storm Sewer

LEGEND — TO BE REMOVED

- Existing Ditch
- Remove Asphalt
- Asphalt Milling
- Driveway Asphalt

B. 07/09/24	Issued for Tender	TN
A. 06/19/24	Issued for Approval	TN
No.	Date	Revision
		By

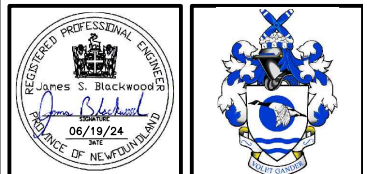

Town of Gander
Department of Engineering
100 Elizabeth Dr. Gander, NL A1V 1G7
Telephone: (709) 651-5915 Fax: (709) 256-5809

Project:
Infrastructure Upgrading 2024
Street Replacement
Part A

Drawing Title:
Memorial Drive East
Removal
(Sta. 0+068.5 to Sta. 0+375.2)

Drawn By:
T. Noseworthy

Scale:
1 : 300

Date:
June 19, 2024

Sheet Number:
1 of 6

Date Plotted:
June 19, 2024

Checked By:
J. Newman

Drawing Number:
24-302-1

Rev. No.
RO

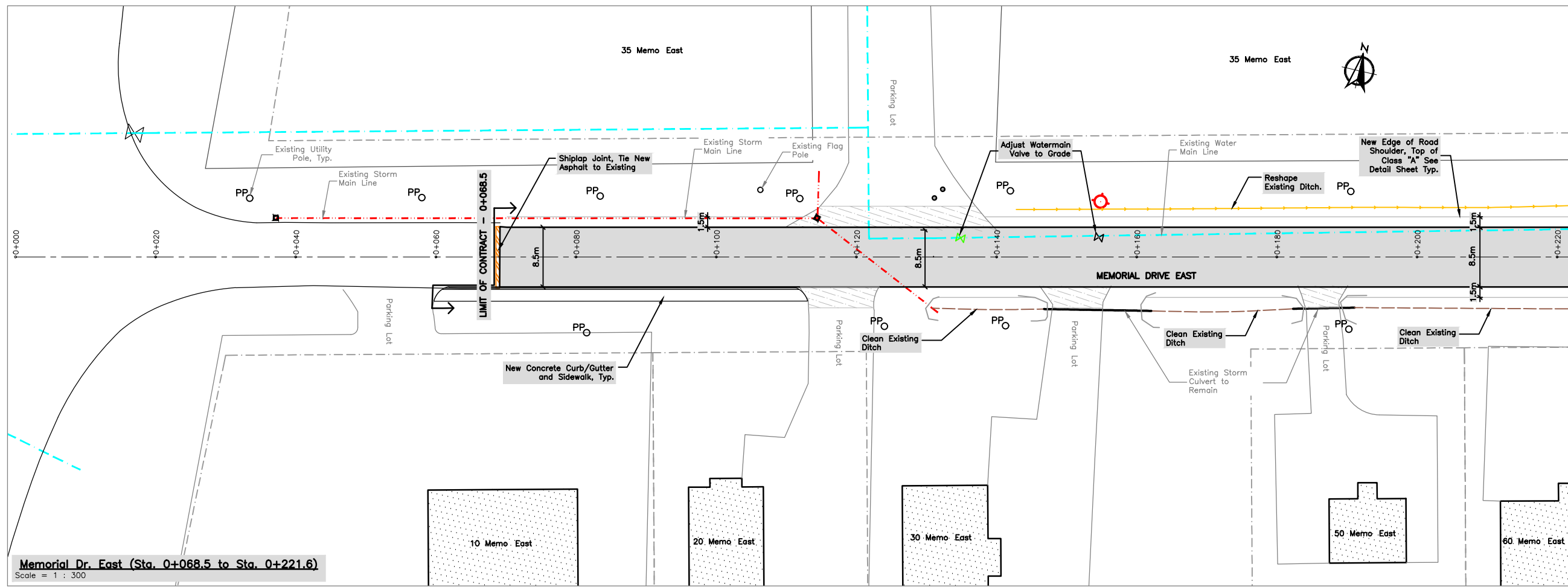

Memorial Dr. East (Sta. 0+068.5 to Sta. 0+221.6)
Scale = 1 : 300

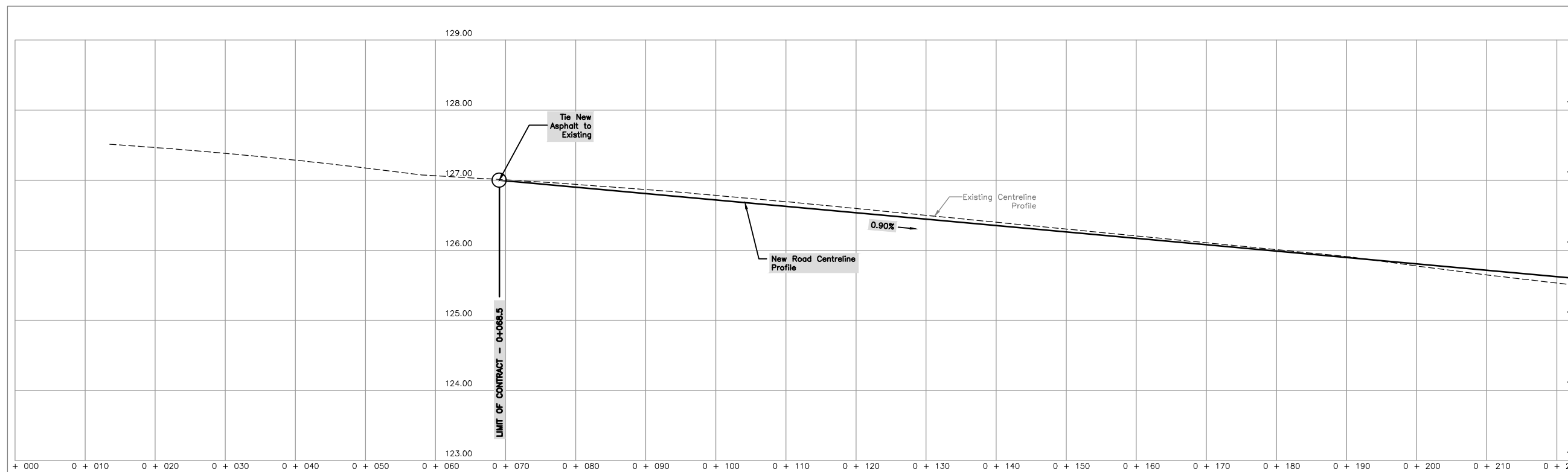

Memorial Dr. East (Sta. 0+068.5 to Sta. 0+221.6)
Scale = 1 : 300

NOTES

1. Unless otherwise noted, all dimensions are in meters.
2. Base course asphalt to be placed at a compacted thickness of 50mm in the areas noted.
3. Surface coarse asphalt to be placed at a compacted thickness of 50mm over the entire surface of the roadway to the limits of construction.
4. Tie new sidewalk into existing landscaping. Achieve positive grade for surface water drainage. Exact limits to be determined by the on-site representative.
5. Tie all asphalt driveways to new asphalt roadway.
6. Tie new road shoulder to existing parking lot entrances.
7. All asphalt and sod excavated to be reinstated as per design, or to its original condition.
8. Road sign definition, SS-stop sign.

-LEGEND-

- Existing Watermain
- Existing Storm Sewer

**-LEGEND-
NEW CONSTRUCTION**

- Curb and Gutter
- Concrete Sidewalk
- Base Course Asphalt
- Roadway Asphalt Patch
- Driveway Asphalt Patch
- Grass Landscaping Area
- Roadway Asphalt

B. 07/09/24	Issued for Tender	TN
A. 06/19/24	Issued for Approval	TN
No.	Date	Revision
		By



Town of Gander
Department of Engineering
100 Elizabeth Dr. Gander, NL A1V 1G7
Telephone: (709) 651-5915 Fax: (709) 256-5809

Project:
Infrastructure Upgrading 2024
Street Replacement
Part A

Drawing Title:
Memorial Drive East
Construction
(Sta. 0+068.5 to Sta. 0+221.6)

Drawn By:
T. Noseworthy

Scale:
1 : 300

Date:
June 19, 2024

Sheet Number:
2 of 6

Date Plotted:
June 19, 2024

Checked By:
J. Newman

Drawing Number:
24-302-2

Rev. No.
RO

NOTES

1. SEE SHEET 2 FOR GENERAL CONSTRUCTION NOTES.

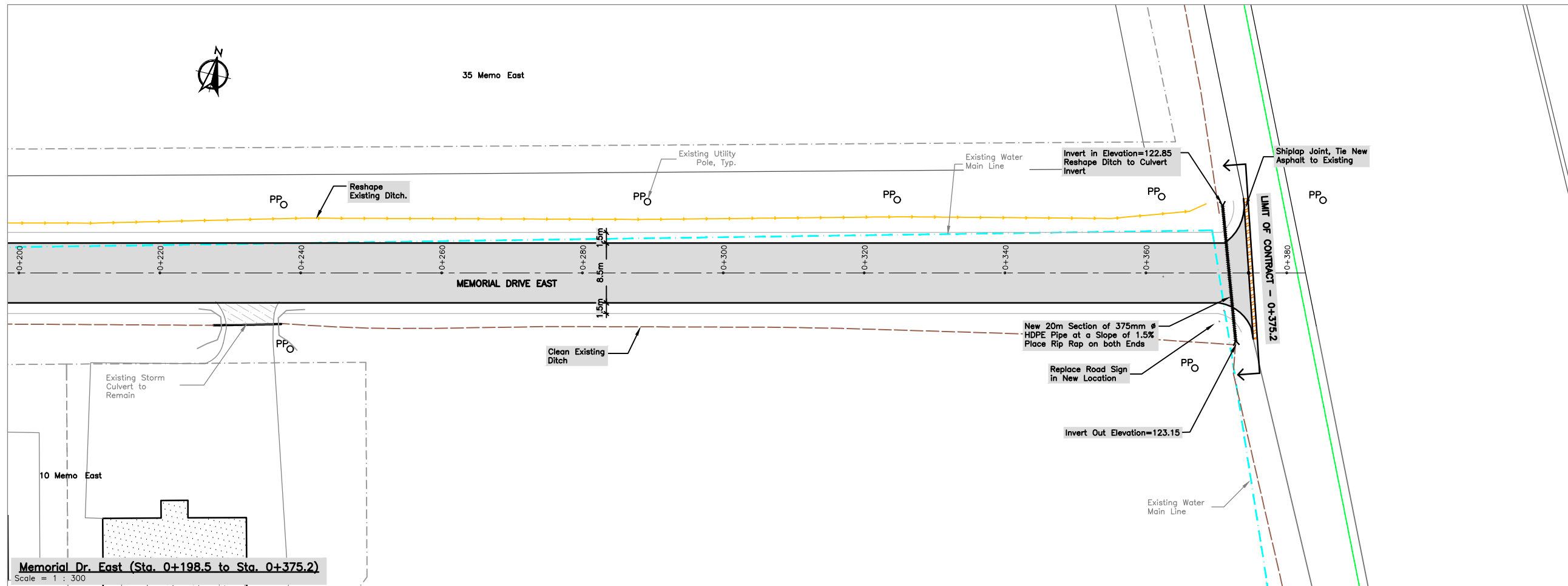

Memorial Dr. East (Sta. 0+198.5 to Sta. 0+375.2)

Scale = 1 : 300

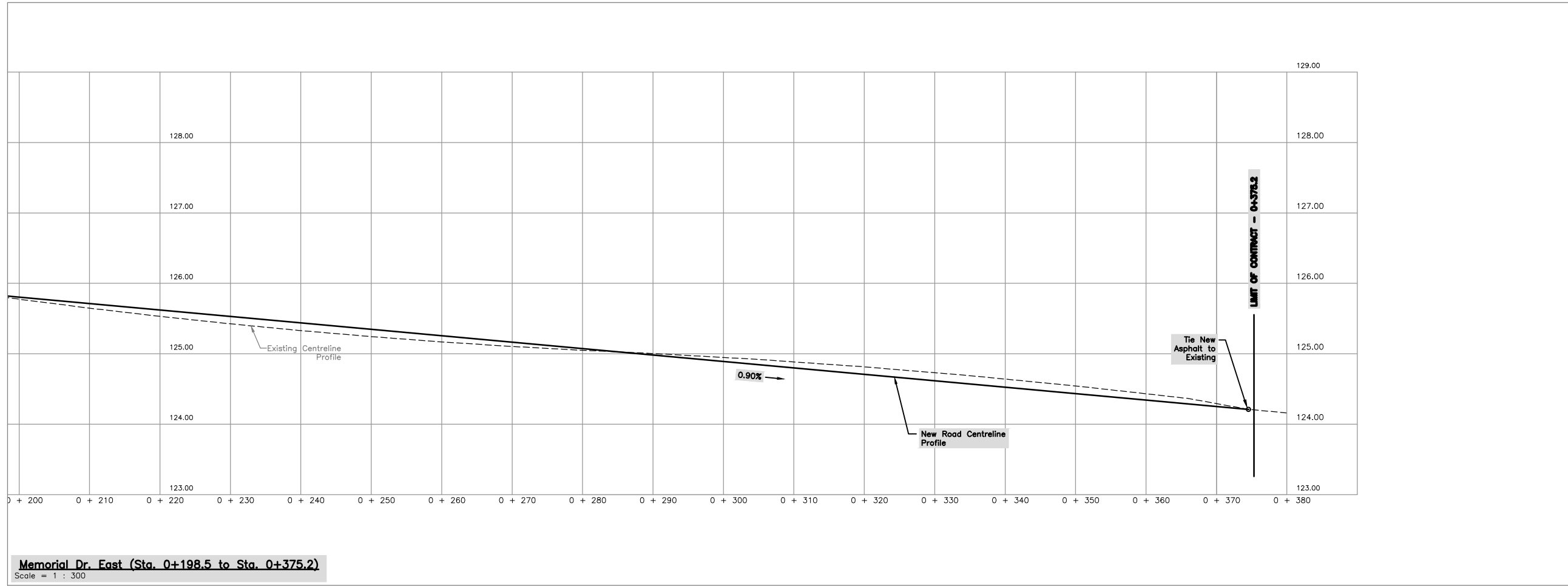

Memorial Dr. East (Sta. 0+198.5 to Sta. 0+375.2)

Scale = 1 : 300

B. 07/09/24	Issued for Tender	TN
A. 06/19/24	Issued for Approval	TN
No.	Date	Revision
		By



Town of Gander
 Department of Engineering
 100 Elizabeth Dr. Gander, NL A1V 1G7
 Telephone: (709) 651-5915 Fax: (709) 256-5809

Project:
 Infrastructure Upgrading 2024
 Street Replacement
 Part A

Drawing Title:
 Memorial Drive East
 Construction
 (Sta. 0+198.5 to Sta. 0+375.2)

Drawn By:
 T. Noseworthy

Scale:
 1 : 300

Date:
 June 19, 2024

Sheet Number:
 3 of 6

Date Plotted:
 June 19, 2024

Checked By:
 J. Newman

Drawing Number:
 24-302-3

Rev. No.
 R0

NOTES

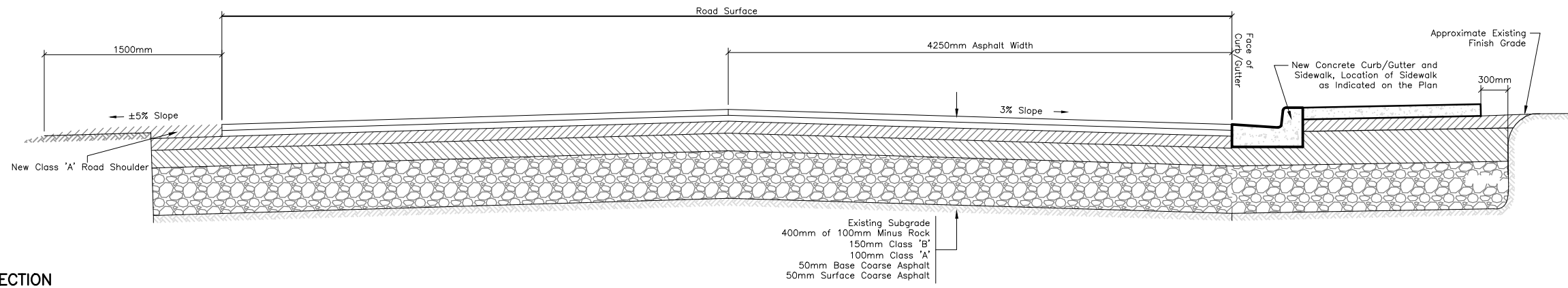

**TYPICAL ROAD SECTION
 STA. 0+068.50 TO STA. 0+113.00**

SCALE - N.T.S.

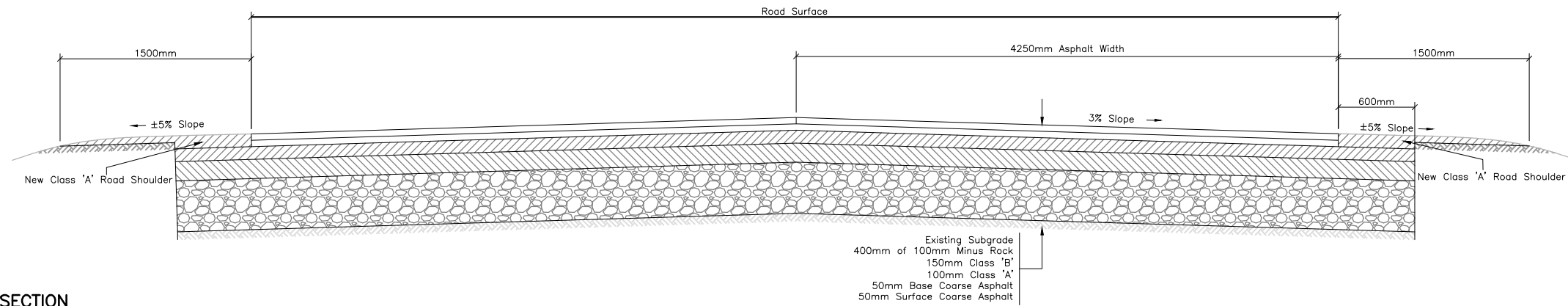

**TYPICAL ROAD SECTION
 STA. 0+113.00 TO STA. 0+382.60**

SCALE - N.T.S.

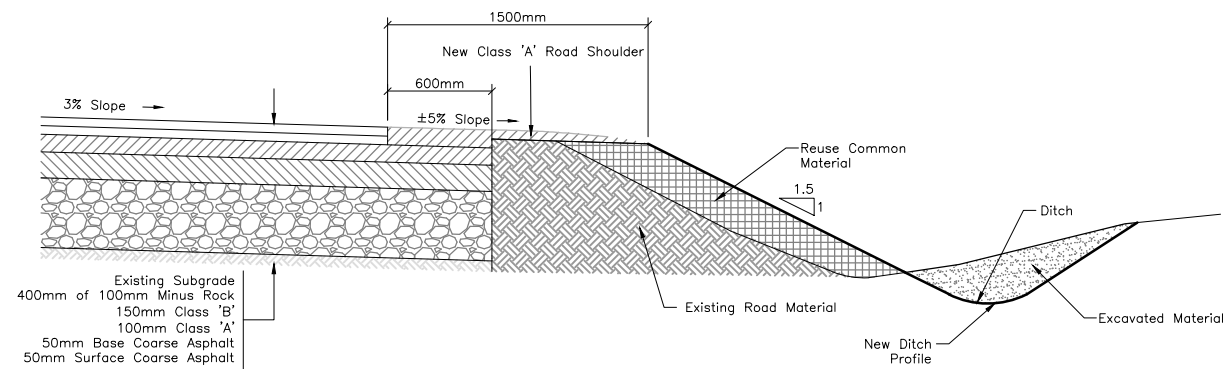

TYPICAL SECTION - ROADWAY WIDENING

SCALE - N.T.S.

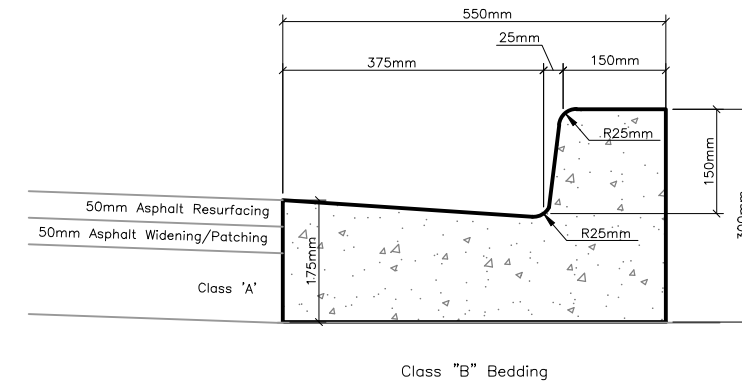

TYPICAL SECTION - CONCRETE CURB AND GUTTER

SCALE - N.T.S.

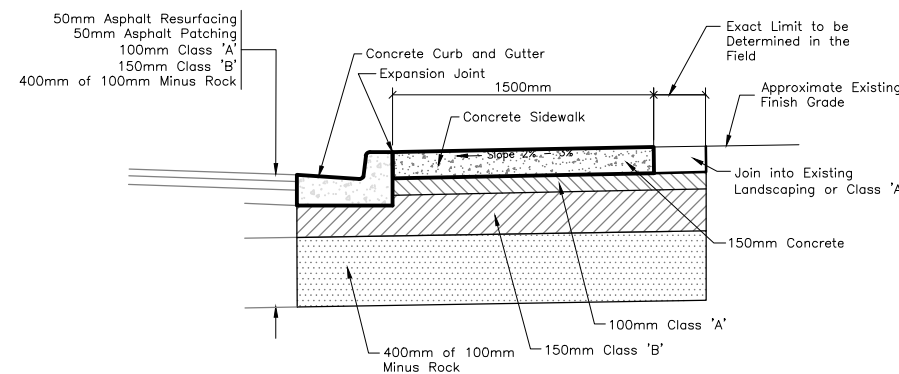

TYPICAL SECTION - CONCRETE CURB/GUTTER AND SIDEWALK

SCALE - 1 : 20

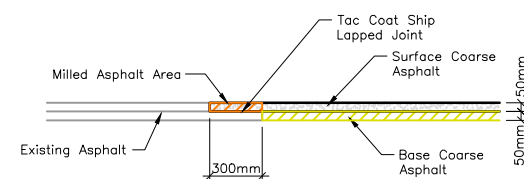

SHIPLAP JOINT - NEW ASPHALT TO EXISTING ASPHALT

SCALE - N.T.S.

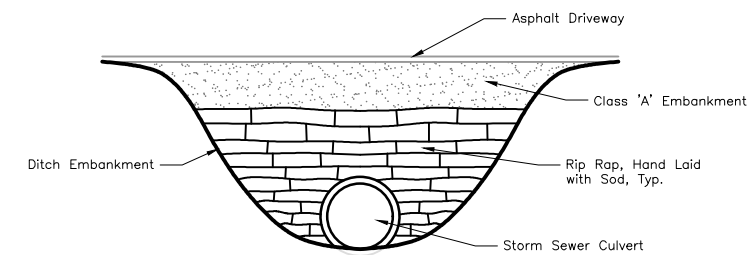

TYPICAL STORM CULVERT RIP RAP DETAIL

SCALE - N.T.S.

B. 07/09/24	Issued for Tender	TN
A. 06/19/24	Issued for Approval	TN
No.	Date	Revision
		By



Town of Gander
 Department of Engineering
 100 Elizabeth Dr. Gander, NL A1V 1G7
 Telephone: (709) 651-5915 Fax: (709) 256-5809

Project:
**Infrastructure Upgrading 2024
 Street Replacement
 Part A**

Drawing Title:
Miscellaneous Details

Drawn By:
T. Noseworthy

Scale:
1 : 300

Date:
June 19, 2024

Sheet Number:
4 of 6

Date Plotted:
June 19, 2024

Checked By:
J. Newman

Drawing Number:
24-302-4

Rev. No.
RO

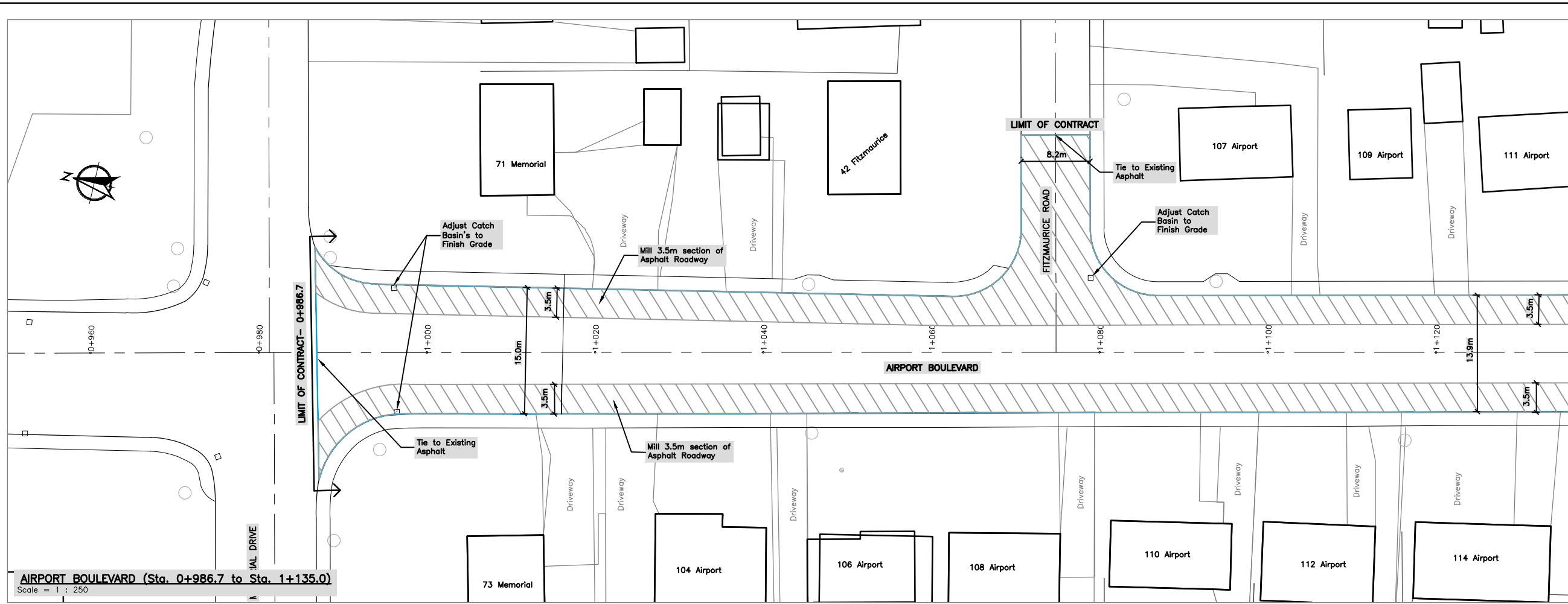

AIRPORT BOULEVARD (Sta. 0+986.7 to Sta. 1+135.0)
Scale = 1 : 250

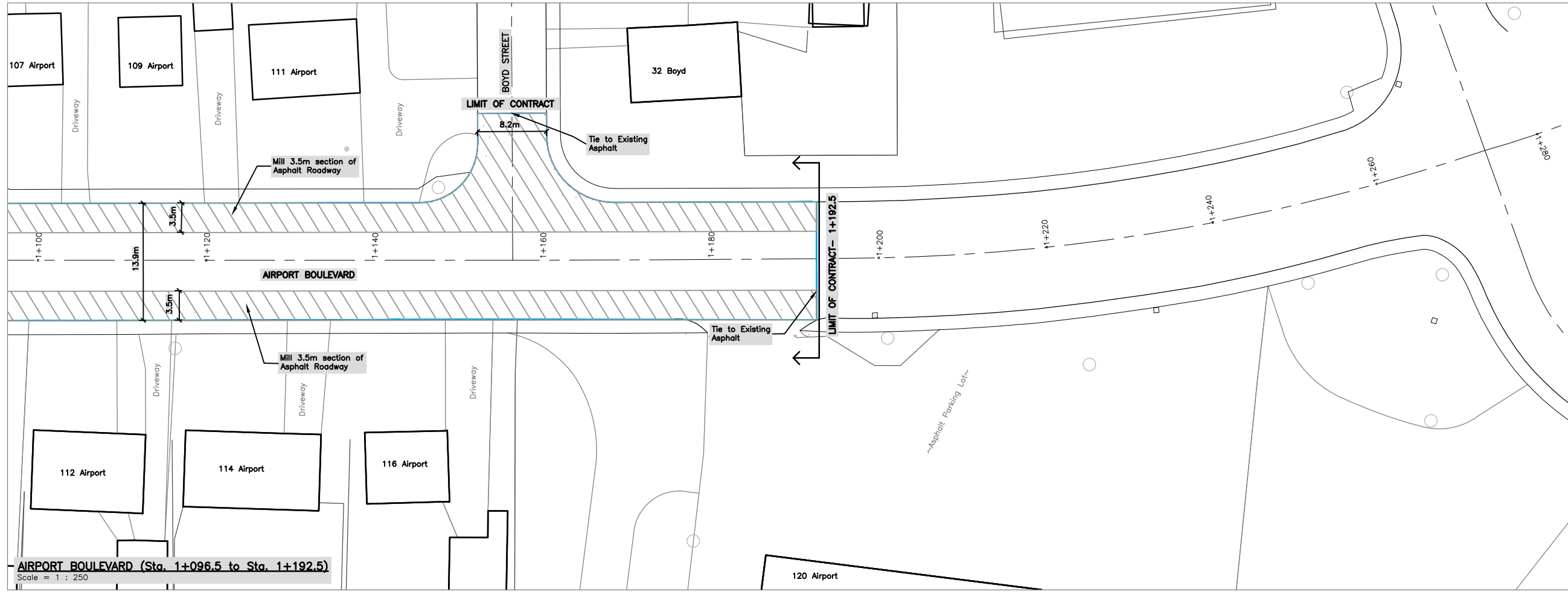

AIRPORT BOULEVARD (Sta. 1+096.5 to Sta. 1+192.5)
Scale = 1 : 250

NOTES

REMOVAL

1. Unless otherwise noted, all dimensions are in meters.
2. Areas as specified in the field by the resident engineer shall be milled to obtain a constant profile. Milled areas indicated may require adjustment.
3. In areas where rutting is below the level of milling or where additional crown is required, leveling course asphalt is to be placed and compacted prior to surface course asphalt.
4. Adjust manhole/catch basin frame/cover/grate's as required.

LEGEND - TO BE REMOVED



CONSTRUCTION

1. Surface course asphalt to be placed at a compacted thickness of 50mm to the limits indicated on the drawing.

LEGEND - NEW CONSTRUCTION

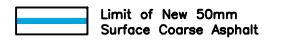

No.	Date	Revision	By
B.	07/09/24	Issued for Tender	TN
A.	06/19/24	Issued for Approval	TN

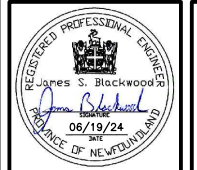

Town of Gander
Department of Engineering
100 Elizabeth Dr. Gander, NL A1V 1G7
Telephone: (709) 651-5915 Fax: (709) 256-5809

Project:
Infrastructure Upgrading 2024
Street Resurfacing
Part B

Drawing Title:
Airport Boulevard
Removal and Construction
(Sta. 0+986.7 to Sta. 1+192.5)

Drawn By: T. Noseworthy Scale: 1 : 250

Date: June 19, 2024 Sheet Number: 1 of 1

Date Plotted: June 19, 2024 Checked By: J. Newman Initial: JN

Drawing Number: 24-302-5 Rev. No. RO

NOTES

REMOVAL

1. Unless otherwise noted, all dimensions are in meters.
2. Areas as specified in the field by the resident engineer shall be milled to obtain a constant profile. Milled areas indicated may require adjustment.
3. In areas where rutting is below the level of milling or where additional crown is required, leveling course asphalt is to be placed and compacted prior to surface coarse asphalt.
4. Adjust manhole/catch basin frame/cover/grate's as required.

LEGEND - TO BE REMOVED



CONSTRUCTION

1. Surface coarse asphalt to be placed at a compacted thickness of 50mm to the limits indicated on the drawing.

LEGEND - NEW CONSTRUCTION



B. 07/09/24	Issued for Tender	TN
A. 06/19/24	Issued for Approval	TN
No.	Date	Revision
		By

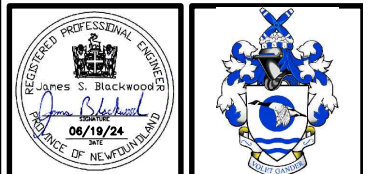

Town of Gander
 Department of Engineering
 100 Elizabeth Dr. Gander, NL A1V 1G7
 Telephone: (709) 651-5915 Fax: (709) 256-5809

Project:
 Infrastructure Upgrading 2024
 Street Resurfacing
 Part C

Drawing Title:
 Rowsell Boulevard
 Removal and Construction
 (Sta. 0+928.8 to Sta. 1+067.8)

Drawn By:
 T. Noseworthy

Scale:
 1 : 300

Date:
 June 19, 2024

Sheet Number:
 1 of 1

Date Plotted:
 June 19, 2024

Checked By:
 J. Newman

Drawing Number:
 24-302-6

Rev. No.
 RO

